



ONWARD HP NON-LIFTED 4-PASSENGER ELECTRIC Operators Manual



**APPLICABLE TO ONWARD HP NON-LIFTED 4-PASSENGER ERIC ELECTRIC
VEHICLES WITH SERIAL PREFIX OF DU**



INTRODUCTION

VEHICLE OWNERSHIP

Congratulations! The Club Car brand is widely recognized as the industry leader in vehicle efficiency and long-lasting value. Read, understand, and obey the technical content in this manual to protect your investment and provide years of reliable vehicle operation.

Read, understand, and obey all instructions and safety precautions in this manual to prevent the risk of personal injury or property damage.

Club Car recommends owners that rent or loan vehicles make sure operators read this manual before vehicle operation.

Club Car recommends owners register their vehicles immediately after purchase. The previous owner must include this manual with the vehicle when sold to a new owner. Registration of the vehicle will make sure Club Car is able to communicate necessary information directly to owners. Send your name, address, and serial number of the vehicle to:

Club Car, LLC
Attention: Vehicle Registration
P.O. Box 204658
Augusta, Georgia 30917-4658
United States Of America

CALIFORNIA PROPOSITION 65

 **WARNING**

OPERATING, SERVICING AND MAINTAINING A PASSENGER VEHICLE OR OFF-ROAD VEHICLE CAN EXPOSE YOU TO CHEMICALS INCLUDING ENGINE EXHAUST, CARBON MONOXIDE, PHTHALATES, AND LEAD, WHICH ARE KNOWN TO THE STATE OF CALIFORNIA TO CAUSE CANCER AND BIRTH DEFECTS OR OTHER REPRODUCTIVE HARM. TO MINIMIZE EXPOSURE, AVOID BREATHING EXHAUST, DO NOT IDLE THE ENGINE EXCEPT AS NECESSARY, SERVICE YOUR VEHICLE IN A WELL-VENTILATED AREA AND WEAR GLOVES OR WASH YOUR HANDS FREQUENTLY WHEN SERVICING YOUR VEHICLE. FOR MORE INFORMATION GO TO WWW.P65WARNINGS.CA.GOV/PASSENGER-VEHICLE.

APPROVED DEALERS AND DISTRIBUTORS

Club Car's customer support system offers fast and courteous service. Speak with your dealer or distributor for:

- Accessories
- Publications
- Replacement Parts
- Technical Advice
- Warranty Work



To find your nearest dealer or distributor:

- Visit www.clubcardealer.com
- Scan the dealer locator Quick Response (QR) code

COMPANY CONTACT INFORMATION

Send written correspondence to:

Club Car, LLC
Attention: Marketing Services
P.O. Box 204658
Augusta, Georgia 30917-4658
United States Of America

CUSTOMER SATISFACTION SURVEY

Let your voice be heard!

Your feedback will help improve our publications. You can access the survey through any internet-connected device with a web browser. The survey is available in many different languages.

Scan the Quick Response (QR) code or type the web address <http://bit.ly/1w9uFMh> to complete the survey.



NOTICES

VEHICLE MODEL AND SERIAL NUMBER

The vehicle serial number is located on a bar code decal installed below the passenger-side cup holder.

1. A two-letter code that identifies the vehicle model.
2. A four-digit code that identifies the model year and production week the vehicle was assembled.
3. A unique six-digit number given to each vehicle built within a specified model year.



LIABILITY AND VEHICLE DESIGN CHANGES

Club Car is not liable for errors in this manual or for incidental or consequential damages that result from the use of the material in this manual.

Club Car reserves the right to make design changes to vehicles without obligation to make these changes on units previously sold.

This manual is the original instructions provided by the manufacturer if in English. This manual is a translation of the original instructions if in any language other than English.

VEHICLE MODIFICATIONS

 **DANGER**

MODIFICATIONS OR CHANGES TO THE VEHICLE THAT AFFECT THE OCCUPANT RETENTION, ELECTRICAL SYSTEM, STABILITY OR HANDLING OF THE VEHICLE, OR INCREASES THE MAXIMUM VEHICLE SPEED CAN CAUSE SERIOUS PERSONAL INJURY OR DEATH.

 **NOTICE**

MODIFICATIONS TO THE VEHICLE MUST NOT COMPROMISE COMPLIANCE WITH STATE OR FEDERAL REGULATIONS.

Do not install non-Club Car approved accessories or change the vehicle function to increased speed or power. Modifications or installation of non-Club Car approved accessories could cause a substantial safety hazard and increase the risk of bodily injury or property damage.

Modifications may void the warranty. Refer to the warranty for more details.

The performance characteristics of the vehicle may change because of the addition of some accessories, including (but not limited to) lift kits, tires, or large racks. Use only Club Car approved accessories. Know the function of the accessories and their effects on the vehicle.

VEHICLE WARRANTY

Warranty information is located in the warranty section of this manual. No other expressed or implied warranties are contained herein.

Your dealer or distributor examined the vehicle before it was delivered to you. The dealer or distributor will also supply you a copy of the completed vehicle warranty registration form.

GOVERNMENTAL AND INDUSTRY STANDARDS

AMERICAN NATIONAL STANDARDS INSTITUTES ANSI Z135

The configuration of this vehicle complies with American National Standards Institutes (ANSI) Z135 Safety Standards for Personal Transport Vehicles (PTVs). The vehicle should only be operated in areas approved for PTV operation. The words "PTV" and "vehicle" are used inter-changeably in this manual.

U.S.A. FEDERAL VEHICLE SAFETY STANDARDS

The configuration of this vehicle does not comply with United States Of America Federal Motor Vehicle Safety Standards (FMVSS) for automobiles and FMVSS 500 for low-speed vehicles as it existed on the date the vehicle was shipped from the Club Car manufacturing facility. This four-wheel general-purpose vehicle is intended to transport people and cargo on improved or groomed surfaces.

CANADIAN STANDARD ICES-002

This vehicle complies with CAN ICES-2 / NMB-2 as it was on the date the vehicle was shipped from the Club Car manufacturing facility.

EUROPEAN UNION VIBRATION AND NOISE PREN 15997

European Union specification prEN 15997 was used to measure the vibration and noise levels of the vehicle. The vibration and noise values are recorded in the vehicle specification section of this manual.

EUROPEAN UNION DIRECTIVES

This vehicle, when marked with a CE decal, complies with:

- 2014/30/EU
- 2006/42/EC
- 2006/66/EC
- 2014/35/EC

The following standards were used:

- EN ISO 12100:2010
- EN ISO 13857:2008
- EN 60204-1
- EN 61000-6-2:2005
- EN 61000-6-4:2007/A1:2011
- EN 60335-2-29:2004

PUBLICATION COPYRIGHT

This manual contains proprietary information that is protected by copyright. All rights are reserved. Express written consent of Club Car, LLC is necessary to photocopy, replicate, or translate this manual. The information contained in this publication is subject to change without notice.

CONTENTS

INTRODUCTION	I
---------------------------	----------

NOTICES	III
----------------------	------------

SECTION 1 – SAFETY INFORMATION	9
---	----------

General Safety Information	10
Practice Safety.....	10
Safety Signal Words	10
Safety Committee	11
Vehicle Safety Information.....	11
Vehicle Safety And Compliance Decals.....	12
Vehicle Safety Features	15
Battery Charging Interlock	15
Multi-Purpose Buzzer	15
Regenerative Braking.....	15
Walk-Away Braking	16
Battery Safety Information	16
Battery International Safety Symbols	17
Lead-Acid Battery Recycling	17

SECTION 2 – INDICATORS, GAUGES, AND DISPLAYS	19
---	-----------

Indicator, Gauge, And Display Locations	20
Dash Display	20

SECTION 3 – VEHICLE CONTROLS.....	25
--	-----------

Vehicle Controls Locator	26
Accelerator Pedal	27
Brake Pedal	27
Forward / Neutral / Reverse Control	27
Hazard Light Switch.....	28
Headlight Switch.....	28
Horn.....	28
Key Switch.....	28
Park Brake.....	29
Run/Tow Switch	30
Turn Signal Lever	30

SECTION 4 – VEHICLE FEATURES.....	31
--	-----------

Vehicle Features Description	32
Fold-Down Rear Seat.....	32
USB Receptacle.....	32

SECTION 5 – BATTERY CHARGER	33
--	-----------

Introduction	34
ERIC IC650 Specifications.....	35
Manufacturer Information	35
Dimension And Weight	35
Operational Temperature	35
AC Input.....	36
DC Output.....	36
Governmental And Industry Certifications	36

European Conformity	36
Federal Communications Commission	36
International Protection Marking	36
Underwriters Laboratories And Canadian Standards Association	37
Features	37
AC Electrical Cord And Plug	37
Status Indicator Lights	37
Battery Charging Interlock	39
External Battery Charger Mounting	39
How To Make Strain Relief And Drip Loop	40
Inspection And Maintenance	40
Electrical Cords	40
Electrical Plugs And Receptacles	40
Clean The Electrical Plugs And Receptacles	41
Battery Charger USB Receptacle	41
Clean The USB Receptacle	41

SECTION 6 – VEHICLE SPECIFICATIONS..... 43

Dimensions	44
Performance.....	44
Tires	44
Electric Motor	44
Batteries.....	44
Noise And Vibration	45
Transaxle.....	45
Vehicle Weights And Load Capacities.....	45

SECTION 7 – VEHICLE OPERATION 47

Daily Pre-Operational Safety And Performance Checks.....	49
Overview.....	49
Daily Pre-Operational Safety Checklist	50
Vehicle Performance Inspection	50
Vehicle Movement.....	52
Overview.....	52
Motor Start	52
Turn Off Motor.....	52
Forward Movement	53
Reverse Movement.....	53
Slow Or Stop The Vehicle	54
Park The Vehicle	54
Driving Conditions	54
Unpaved Surfaces	54
Uphill Slope	54
Side Hill Slope	55
Downhill Slope.....	55
Over Obstacles	56
Below Obstacles	56
Night Time	57
Through Water.....	57
With Cargo	57

SECTION 8 – VEHICLE MAINTENANCE 59

Disable The Vehicle	60
Vehicle Cleaning.....	61
Windshield	61
Vehicle Exterior	61
Vehicle Interior	61
Maintenance Schedule	61
Overview.....	61



Service Schedule	62
Maintenance Tasks	63
Lift The Vehicle	63
Lower The Vehicle	65
Tire Pressure Measurement	67
Wheel Assembly	67
SECTION 9 – BATTERY MAINTENANCE	69
<hr/>	
Battery Cleaning	70
Battery Charging	70
Charging With External Charger	70
Charging With Onboard Charger	72
Battery Electrical Connection	73
Disconnect	73
Connect	74
Battery Hold-Down	75
Add Water To A Battery Without Single Point Watering System	75
Deionizer	77
Add Water To Batteries With Single Point Watering System	77
Watering Intervals	77
Water Quality	77
Overview	77
Preferred Sources	78
Alternate Sources	78
Water Impurity	78
SECTION 10 – TRANSPORT AND TOW	81
<hr/>	
Prepare The Vehicle To Be Towed	82
Towing A Trailer Or Vehicle	82
Vehicle Transport Preparation	82
Vehicle Transport Recovery	83
SECTION 11 – EXTENDED STORAGE	85
<hr/>	
Extended Storage Preparation	86
Return To Service From Extended Storage	87
SECTION 12 – WARRANTIES	89
<hr/>	
Limited Warranty	90
Warranty	90
Warranty Timeframe	90
Exclusions	91
Voiding Of Warranty	92
Sole Remedy	92
Disclaimer	92
No Consequential Damages	92
How To Make A Warranty Claim	93

(Page intentionally left blank.)



1

SAFETY INFORMATION

GENERAL SAFETY INFORMATION

PRACTICE SAFETY

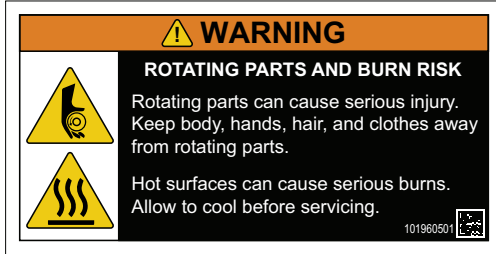

Signal words (DANGER, WARNING, CAUTION, and NOTICE) and safety messages are in this manual and on safety decals. Read, understand, and obey all instructions, safety precautions, and safety decals before vehicle operations.

Replace missing, damaged, or unreadable safety decals immediately to prevent possible property damage, personal injury, or death. Purchase replacement safety decals from your dealer or distributor.

Know and understand all laws and regulations for vehicle operation in your area.

Speak with your dealer or distributor if you have questions about material contained in this manual or the vehicle.



SAFETY SIGNAL WORDS



Signal words (DANGER, WARNING, CAUTION, and NOTICE) and safety messages are in this manual and on safety decals. Read, understand, and obey all instructions, safety precautions, and safety decals before vehicle operations.

Safety messages are necessary and must be obeyed.



The safety alert symbol is used to alert you to possible personal injury hazards. Obey all safety messages that follow this symbol to prevent possible injury or death.

SAFETY SIGNAL WORD	SIGNIFICANCE
	A DANGER identifies a hazardous situation which will result in death or serious injury.
	A WARNING identifies a hazardous situation which could result in death or serious injury.

SAFETY SIGNAL WORD	SIGNIFICANCE
	<p>A CAUTION identifies a hazardous situation which could result in minor or moderate injury.</p>
	<p>A NOTICE identifies a hazardous situation which could result in property damage.</p>

SAFETY COMMITTEE

If the vehicle is rented or part of a fleet, Club Car recommends a safety committee. The primary concern of the safety committee is safe vehicle operation.

Safety committee objectives include:

- Approve vehicle operation areas.
- Identify all hazards.
- Identify who is approved to operate the vehicle.
- Keep the vehicles in a safe and serviceable condition.
- Supply instructions on safe vehicle operation.
- Visually show all hazards.

VEHICLE SAFETY INFORMATION



FAILURE TO OBEY INSTRUCTIONS IN THIS MANUAL CAN CAUSE PROPERTY DAMAGE, SERIOUS PERSONAL INJURY, OR DEATH. BEFORE YOU OPERATE THE VEHICLE OR DO THE SERVICING OF THE VEHICLE, READ AND FULLY UNDERSTAND THE OWNER'S MANUAL.

CLUB CAR VEHICLES ARE NOT RATED FOR OPERATION IN EXPLOSIVE AREAS. THE VEHICLE OR BATTERY CHARGER CAN CAUSE FLAMMABLE MATERIAL AND FUME IGNITION. DO NOT OPERATE THE VEHICLE OR BATTERY CHARGER NEAR FLAMMABLE MATERIALS AND FUMES.

THE VEHICLE DOES NOT GIVE PROTECTION FROM LIGHTNING, FLYING OBJECTS, OR OTHER STORM RELATED HAZARDS. DO NOT OPERATE THE VEHICLE IN STORMS. STOP THE VEHICLE. GET OUT OF THE VEHICLE IMMEDIATELY AND FIND A SHELTER IN ACCORDANCE WITH APPLICABLE SAFETY GUIDELINES FOR YOUR LOCATION IF IN A STORM.

UNINTENDED VEHICLE OPERATION CAN CAUSE SERIOUS PERSONAL INJURY OR DEATH. MAKE SURE THAT CHILDREN ARE ALWAYS SUPERVISED IN AND AROUND THE VEHICLE.

DO NOT OPERATE THE VEHICLE UNDER THE INFLUENCE OF ALCOHOL, DRUGS, MEDICATIONS, OR WHILE DISTRACTED.

⚠ WARNING

ELECTRICAL SHORTS CAN CAUSE A FIRE, ELECTRICAL SHOCK, SERIOUS PERSONAL INJURY, OR DEATH. PREVENT CONTACT BETWEEN POSITIVE VOLTAGE AND THE GROUND CIRCUIT. USE INSULATED TOOLS.

TO HELP PREVENT BEING HIT, DO NOT STAND IN FRONT OF OR BEHIND THE VEHICLE.

ONLY TRAINED TECHNICIANS SHOULD SERVICE OR REPAIR THE VEHICLE. ANYONE DOING EVEN SIMPLE REPAIRS OR SERVICE SHOULD HAVE KNOWLEDGE AND EXPERIENCE IN ELECTRICAL AND MECHANICAL REPAIR. THE APPROPRIATE INSTRUCTIONS MUST BE USED WHEN PERFORMING MAINTENANCE, SERVICE, OR ACCESSORY INSTALLATION.

VEHICLE SAFETY AND COMPLIANCE DECALS

⚠ WARNING

MAKE SURE ALL OF THE SAFETY AND OPERATION DECALS ARE IN THE CORRECT LOCATION ON THE VEHICLE. REPLACE THE SAFETY AND OPERATION DECALS THAT ARE MISSING OR DAMAGED.

Understand and obey all safety decals. The instructions on these safety decals must be followed in order to prevent the risk of dangerous personal injury or property damage.

Use a soft moist cloth to clean the decals. Do not use solvents, gasoline, or other chemicals to clean the decals. Do not pressure wash decals.

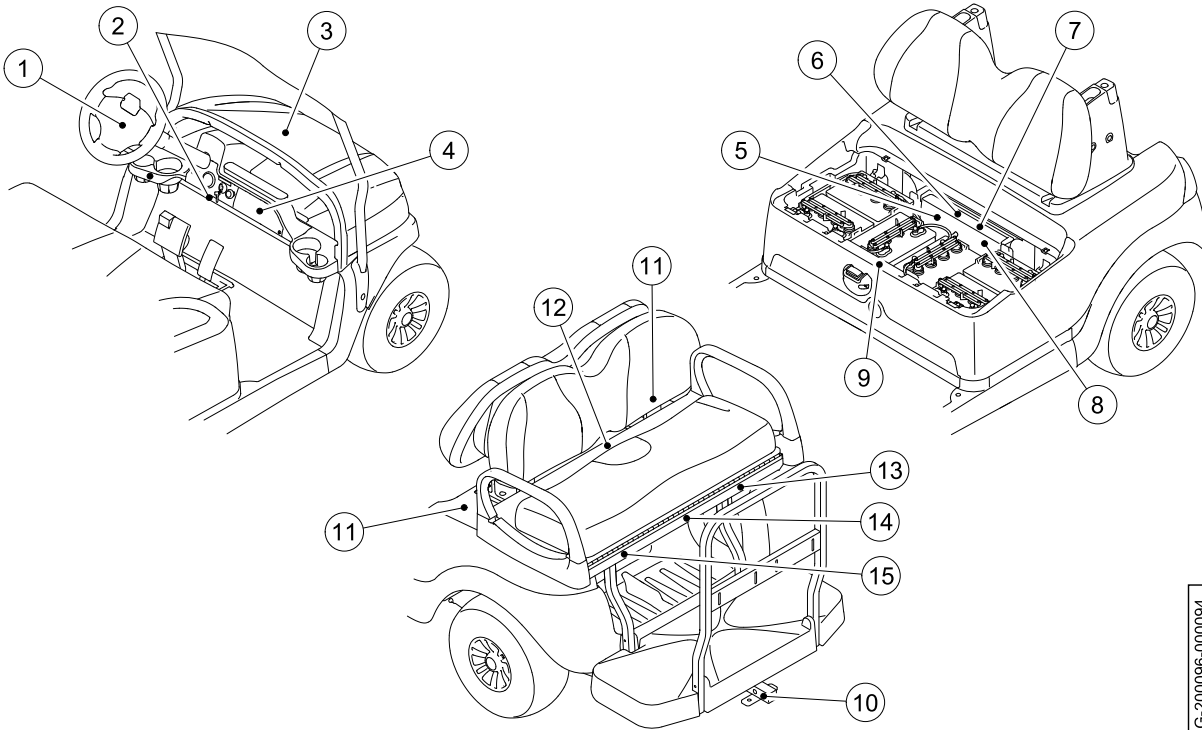

G-200096-000094

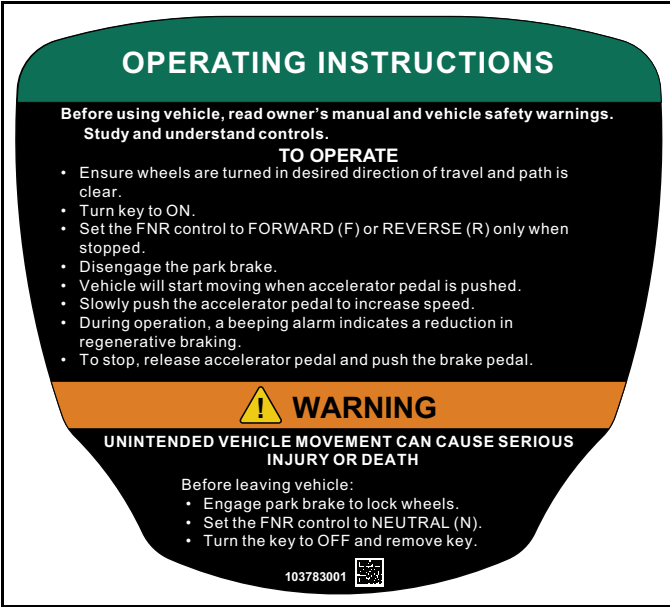

1. Operating Instructions Decal



2. Vehicle Movement Warning Decal



3. Windshield Warning Decal

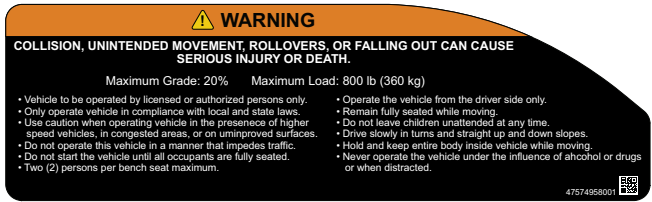



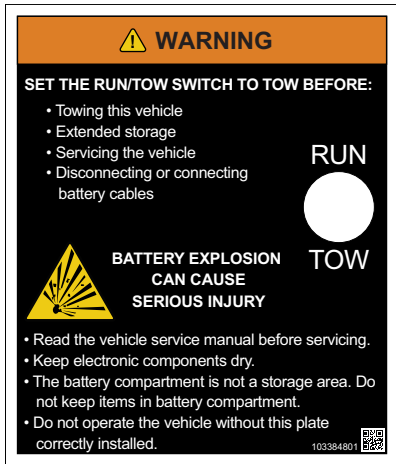

4. Rollover Warning Decal

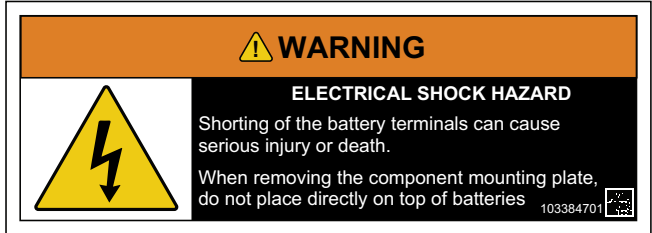

5. Run / Tow Warning Decal

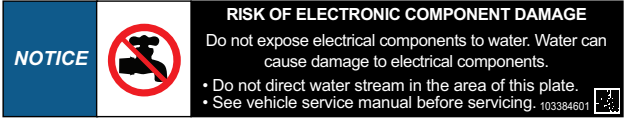

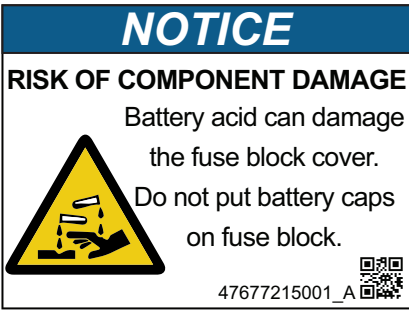
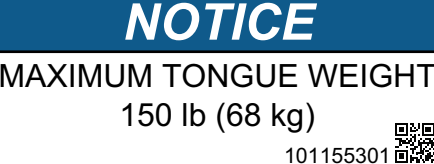
6. Battery Terminal Warning Decal

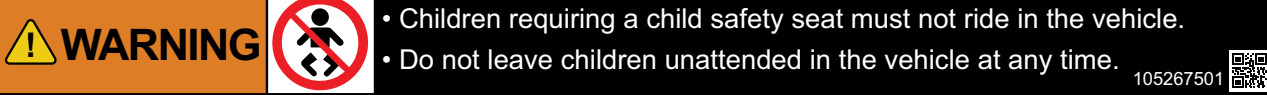
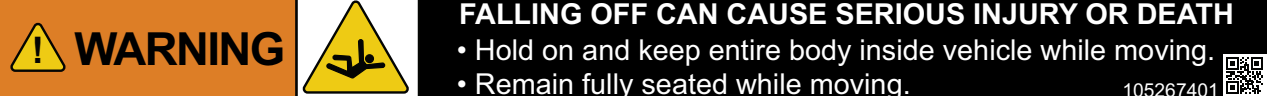
	<p>This vehicle complies with Part III of the ANSI / ILTVA Z135 - PTV Safety Standard when equipped with rear view mirrors.</p> <p>47586191001 </p>
<p>7. Water Exposure Caution Decal</p>	<p>8. Vehicle Compliance Decal</p>
	
<p>9. Fuse Block Notice Decal</p>	<p>10. Trailer Hitch Notice Decal</p>
	
<p>11. Crush Area Warning Decal</p>	<p>12. Box Bed Warning Decal</p>
	
<p>13. Children Unattended Warning Decal</p>	
	

14. Hold On Warning Decal

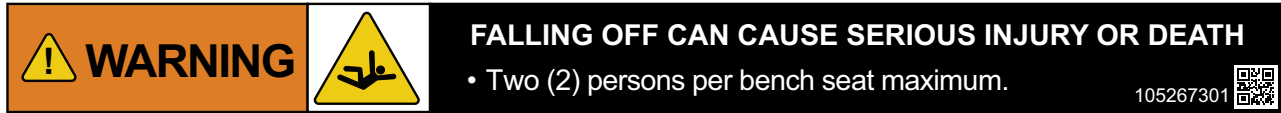

15. Falling Off Warning Decal

VEHICLE SAFETY FEATURES

BATTERY CHARGING INTERLOCK

External Battery Charger: The battery charging interlock is a safety feature that prevents possible damage to the battery charger and vehicle. The battery charging interlock will automatically engage when the DC cord is connected to the vehicle. The vehicle will not operate when the DC cord is connected.

Note: The AC cord does not have to be connected for the battery charging interlock to operate.

Onboard Battery Charger: The battery charging interlock is a safety feature that prevents possible damage to the battery charger and vehicle. The battery charging interlock will automatically engage when the AC cord is connected to a power source. The vehicle will not operate when the AC cord is connected.

MULTI-PURPOSE BUZZER

The vehicle comes equipped with a multi-purpose buzzer. The multi-purpose buzzer makes an audible tone when:

- The Forward / Neutral / Reverse control (FNR) is set to R.
- The walk-away braking engages for longer than two seconds.
- The regenerative braking performance decreases because the batteries are fully charged.
- The batteries start to charge.

REGENERATIVE BRAKING



WHEN THE BATTERIES ARE FULLY CHARGED, A WARNING BUZZER WILL OPERATE DURING REGENERATIVE BRAKING TO TELL THE DRIVER THAT REGENERATIVE BRAKING PERFORMANCE WILL DECREASE. USE THE BRAKE PEDAL TO CONTROL THE VEHICLE SPEED.

Regenerative braking helps maintain the downhill speed of the vehicle in relation to the accelerator pedal position.

Regenerative braking performance decreases when the batteries are fully charged.

Regenerative braking cannot maintain the vehicle speed on an excessive grade (more than 20%). Use the brake pedal to control the vehicle speed.

ACCELERATOR PEDAL POSITION	CONDITION
Fully Pushed	Regenerative braking holds the vehicle at the programmed top speed.
Between Fully Pushed And Released	Regenerative braking holds the vehicle at a percentage of the programmed top speed in relation to the accelerator pedal position.
Fully Released	<p>Regenerative braking will do one of the two based on the controller settings:</p> <ul style="list-style-type: none"> • Factory Default - Stop the vehicle slowly. • Optional - Let the vehicle coast freely. <p><i>Note:</i> The regenerative braking functions are controlled by the controller settings. Speak with your dealer or distributor for more information.</p>

WALK-AWAY BRAKING

WARNING

WALK-AWAY BRAKING WILL NOT LIMIT VEHICLE SPEED TO 3 MPH (4.8 KM/H) ON STEEP SLOPES. DO NOT OPERATE THE VEHICLE ON SLOPES THAT ARE MORE THAN A 20% GRADE.

Walk-away braking is a safety function that limits the roll-away speed of a vehicle when the park brake is disengaged. The multi-purpose buzzer will make an audible tone when the walk-away braking safety device engages for more than two seconds.

BATTERY SAFETY INFORMATION

DANGER

BATTERY ACID CAN CAUSE SERIOUS BURNS. PREVENT CONTACT WITH SKIN, EYES, AND CLOTHING. WEAR A FULL FACE SHIELD AND RUBBER GLOVES WHEN SERVICING A BATTERY. ANTIDOTES: EXTERNAL: FLUSH WITH WATER. CALL A PHYSICIAN IMMEDIATELY. INTERNAL: DRINK LARGE QUANTITIES OF MILK OR WATER FOLLOWED WITH MILK OF MAGNESIA OR VEGETABLE OIL. CALL A PHYSICIAN IMMEDIATELY. EYES: FLUSH WITH WATER FOR 15 MINUTES. CALL A PHYSICIAN IMMEDIATELY.

WARNING

FROZEN BATTERY ACID CAN CAUSE DAMAGE INCLUDING LEAKS AND EXPLOSIONS. IF THE BATTERY ACID FREEZES, REPLACE THE BATTERY BEFORE CHARGING OR USE. BATTERIES IN A LOW STATE OF CHARGE WILL FREEZE AT LOW TEMPERATURES. KEEP THE BATTERIES IN A HIGH STATE OF CHARGE.





FLOODED AND SUBMERGED BATTERIES CAN CAUSE DAMAGE INCLUDING LEAKS AND EXPLOSION. IF A BATTERY IS SUBMERGED, REPLACE THE BATTERY BEFORE CHARGING OR USE.

LOOSE BATTERY WIRES CAN CAUSE A FIRE, PROPERTY DAMAGE, OR SERIOUS PERSONAL INJURY. MAKE SURE THAT ALL BATTERY WIRES AND TERMINALS ARE CLEAN AND TIGHTENED CORRECTLY.

BATTERY WIRES WITH DAMAGE OR CORROSION CAN BECOME TOO HOT AND CAUSE A FIRE, PROPERTY DAMAGE, OR SERIOUS PERSONAL INJURY. REPLACE BATTERY WIRES THAT HAVE DAMAGE OR CORROSION. CLEAN CORROSION FROM THE BATTERY TERMINALS.

BATTERY INTERNATIONAL SAFETY SYMBOLS

Understand and obey the international safety symbols on the vehicle battery before you use, repair, or service the vehicle.

SYMBOL	SIGNIFICANCE
	Shield eyes
	Read and obey operation and maintenance instructions
	Do not smoke, No open flames, No sparks
	Keep away from children
	Explosive gas hazard

LEAD-ACID BATTERY RECYCLING



LEAD-ACID BATTERIES CONTAIN DANGEROUS MATERIALS THAT CAN CONTAMINATE THE WATER AND SOIL, CAUSE ENVIRONMENTAL DAMAGE, CAUSE PROPERTY DAMAGE, AND CAUSE SERIOUS PERSONAL INJURY. SPEAK WITH YOUR DEALER OR DISTRIBUTOR FOR INFORMATION ON HOW TO DISCARD A BATTERY CORRECTLY.

Lead-acid batteries and other components which have the Waste Electrical and Electronic Equipment (WEEE) symbol printed on them must be collected and recycled separately from other waste. Do not discard lead-acid batteries as municipal waste.

Speak with your dealer or distributor on how to correctly recycle lead-acid batteries.

(Page intentionally left blank.)

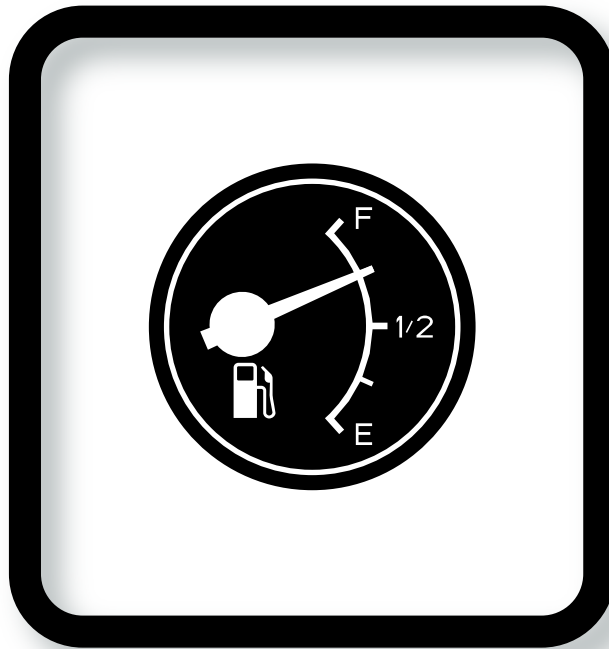

2

INDICATORS, GAUGES, AND DISPLAYS

INDICATOR, GAUGE, AND DISPLAY LOCATIONS

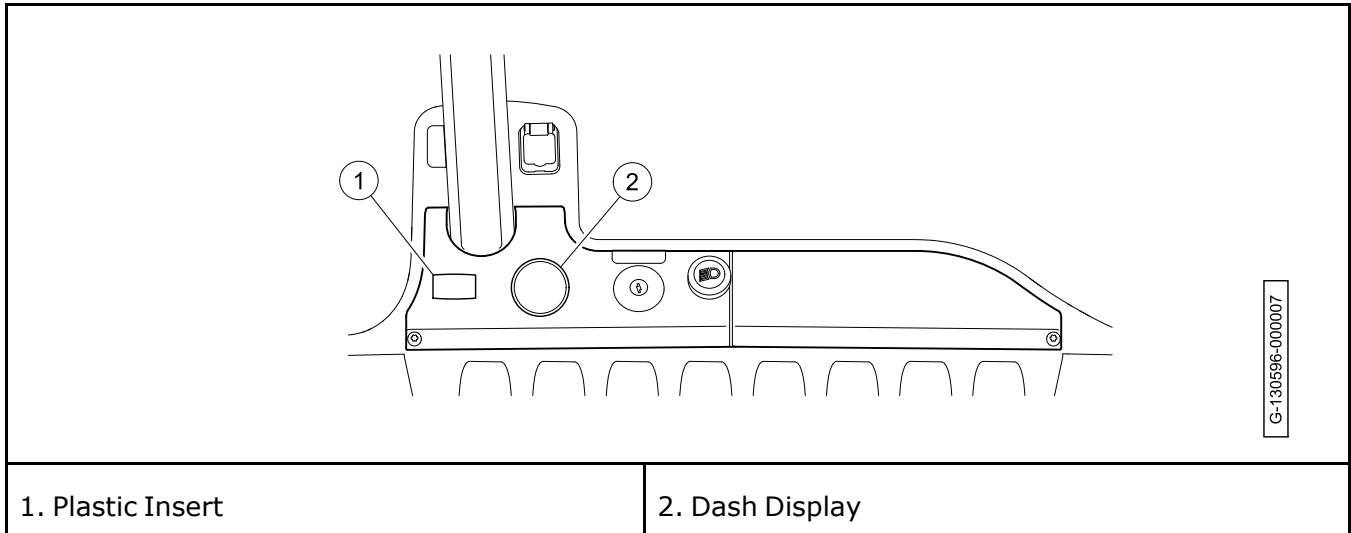

DASH DISPLAY

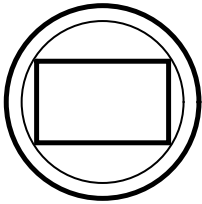







The dash display gives a visual indication of:

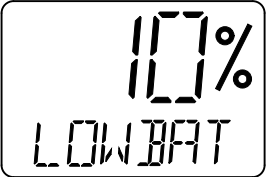
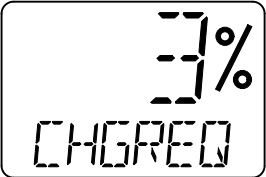
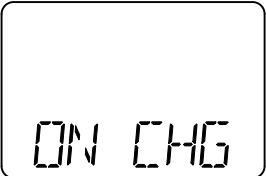

- The battery state of charge (SOC)
- Forward / Neutral / Reverse control (FNR) position
- Turn signal lever position
- Messages

The dash display operates when the key switch is set to ACC, ON, or when the battery is charging.

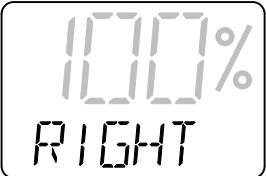
The backlight will dim when the headlight switch is on.

DISPLAY	DESCRIPTION
 <p style="text-align: center; font-size: small;">G-130592-000065</p>	<p>Battery state of charge (SOC)</p> <ul style="list-style-type: none"> • The dash display will show the SOC when the key switch is set to ACC or ON. • 100% to 10% - SOC will show in 10% increments • Less than 10% - SOC will show in 1% increments
 <p style="text-align: center; font-size: small;">G-130592-000060</p>	<p>Battery SOC is 10% or less. Charge the battery as soon as possible.</p>
 <p style="text-align: center; font-size: small;">G-130592-000064</p>	<p>Battery SOC is 3% or less. The multi-purpose buzzer and headlights (if equipped) will operate three times. Immediately charge the battery.</p>
 <p style="text-align: center; font-size: small;">G-130592-000066</p>	<p>Battery is charging</p>
 <p style="text-align: center; font-size: small;">G-130592-000055</p>	<p>FNR is set to N</p>

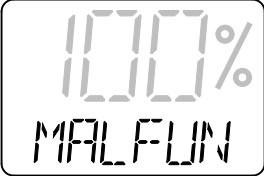
DISPLAY	DESCRIPTION
 <p style="text-align: center; font-size: small;">G-130592-000056</p>	FNR is set to F
 <p style="text-align: center; font-size: small;">G-130592-000057</p>	FNR is set to R
 <p style="text-align: center; font-size: small;">G-130592-000058</p>	Left turn signal is on
 <p style="text-align: center; font-size: small;">G-130592-000059</p>	Right turn signal is on
 <p style="text-align: center; font-size: small;">G-130592-000061</p>	Minor fault. The vehicle will log the event. Speak with your local dealer or distributor.

DISPLAY	DESCRIPTION
 <p style="text-align: center; font-size: small;">G-130592-000062</p>	<p>Malfunction fault. The vehicle may go into limp mode and operate at only 7.6 mph (12.2 kmh). Speak with your local dealer or distributor.</p>
 <p style="text-align: center; font-size: small;">G-130592-000063</p>	<p>Severe fault. When possible, all components except for the dash display will not operate. Speak with your local dealer or distributor.</p>

(Page intentionally left blank.)



3

VEHICLE CONTROLS

VEHICLE CONTROLS LOCATOR

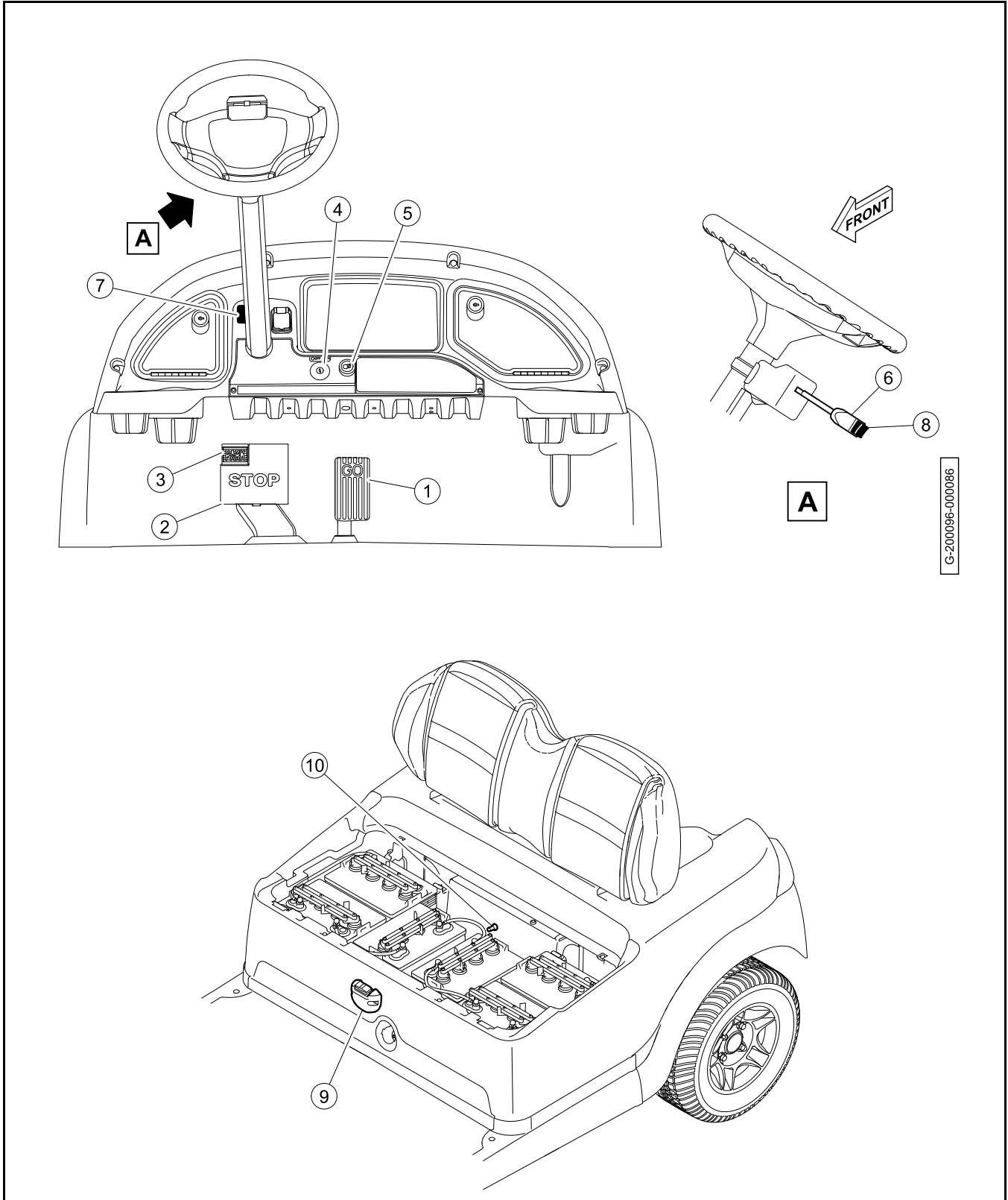

G-200096-000086

1. Accelerator Pedal	2. Brake Pedal
3. Park Brake	4. Key Switch
5. Headlight Switch	6. Turn Signal Lever
7. Hazard Lights Switch	8. Horn Button
9. Forward / Neutral / Reverse Control (FNR)	10. Run/Tow Switch

ACCELERATOR PEDAL

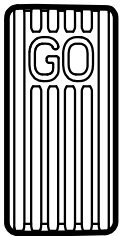

The accelerator pedal is used to increase and maintain the speed of the vehicle.

BRAKE PEDAL

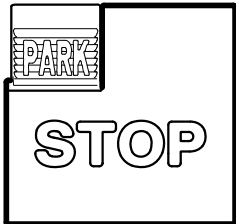

The brake pedal is used to decrease speed or stop the vehicle.

FORWARD / NEUTRAL / REVERSE CONTROL



FAILURE TO STOP THE VEHICLE BEFORE SHIFTING THE FORWARD / NEUTRAL / REVERSE CONTROL (FNR) CAN CAUSE PROPERTY DAMAGE AND SERIOUS PERSONAL INJURY. STOP THE VEHICLE BEFORE SHIFTING THE FORWARD / NEUTRAL / REVERSE CONTROL (FNR).

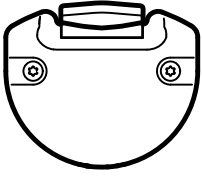

The Forward / Neutral / Reverse control (FNR) sets the direction of vehicle movement.

Stop the vehicle to change the FNR position.

POSITION	FUNCTION
F	Forward
N (Center)	Neutral
R	Reverse

HAZARD LIGHT SWITCH

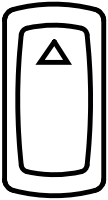

The hazard light switch controls the operation of the hazard lights.

POSITION	FUNCTION
Top	On
Bottom	Off

HEADLIGHT SWITCH

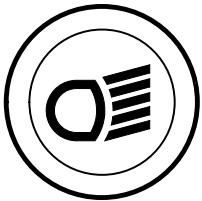

The headlight switch controls the operation of the headlights.

POSITION	FUNCTION
Out	On
In	Off

HORN

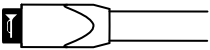

The horn button is used to control the horn. The horn button is spring loaded to stay in the off position. Push and hold the horn button to operate the horn.

Note: The horn will not operate when the key switch is OFF.

KEY SWITCH



WARNING

THE KEY SWITCH CAN BE USED TO STOP THE VEHICLE IN AN EMERGENCY. DO NOT BREAK OFF KEYS IN THE KEY SWITCH.

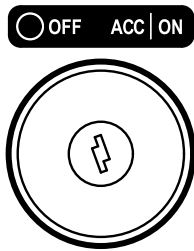

The key switch controls the motor and electrical system. A key is used to select the key switch position. The key can only be inserted or removed when the key switch set to OFF.

POSITION	CONDITION
OFF	<p>Normal position when the vehicle is not in use.</p> <p>Electrical power from the batteries is not available to power the motor or electrical systems.</p> <p><i>Note:</i> Some electrical accessories operate independently of the key switch.</p>
ON	<p>Normal position when the vehicle is in use.</p> <p>Electrical power from the batteries is available to power the motor and electrical systems.</p> <p>After 15 minutes of no accelerator pedal operation, the vehicle will turn off. To turn the vehicle back on, turn the key to OFF, then ON.</p>
ACC	<p>Electrical power from the batteries is available to power some electrical components. No electrical power is available to power the motor.</p> <p>After 2 hours, the vehicle will turn off.</p>

PARK BRAKE

WARNING

FAILURE TO ENGAGE THE PARK BRAKE CAN CAUSE PROPERTY DAMAGE AND SERIOUS PERSONAL INJURY. AFTER THE VEHICLE STOPS, ENGAGE THE PARK BRAKE UNTIL IT IS FULLY ENGAGED AND PREVENTS THE VEHICLE FROM MOVING.

UNINTENDED VEHICLE OPERATION CAN CAUSE SERIOUS PERSONAL INJURY OR DEATH. THE PARK BRAKE WILL RELEASE AUTOMATICALLY WHEN THE ACCELERATOR OR BRAKE PEDAL IS PUSHED. PREVENT ACCIDENTAL ACCELERATOR OR BRAKE PEDAL ACTUATION.

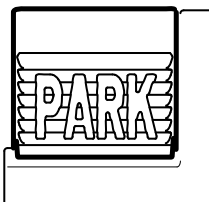

The park brake is a variable position control that is used to make sure that a vehicle does not move while parked.

Push the park brake firmly to engage the park brake.

To disengage the park brake, push the accelerator or brake pedal.

RUN/TOW SWITCH

WARNING

UNINTENDED VEHICLE MOVEMENT CAN CAUSE PROPERTY DAMAGE, SERIOUS PERSONAL INJURY, OR DEATH. WHEN THE RUN/TOW SWITCH IS IN THE TOW POSITION, ALL MOTOR BRAKING FUNCTIONS, INCLUDING WALK-AWAY BRAKING, ARE DISABLED.



The Run/Tow switch is used during towing, maintenance, or extended storage. Set the switch to RUN for normal operation. Set the switch to TOW for maintenance, extended storage, or when towed.

Wait 10 seconds before vehicle operation when the switch is set from TOW to RUN.

Do not quickly operate the switch from RUN to TOW and back to RUN. Wait 10 seconds to set the switch to RUN.

POSITION	FUNCTION
RUN	Normal Operation
TOW	<ul style="list-style-type: none"> • Connect the battery cables. • Disconnect the battery cables. • To do vehicle maintenance. • Put the vehicle into extended storage. • Tow the vehicle.

TURN SIGNAL LEVER



The turn signal lever controls the operation of the turn signal lights. The turn signal light will flash when turned on.

POSITION	FUNCTION
Down	Left
Center	Off
Up	Right

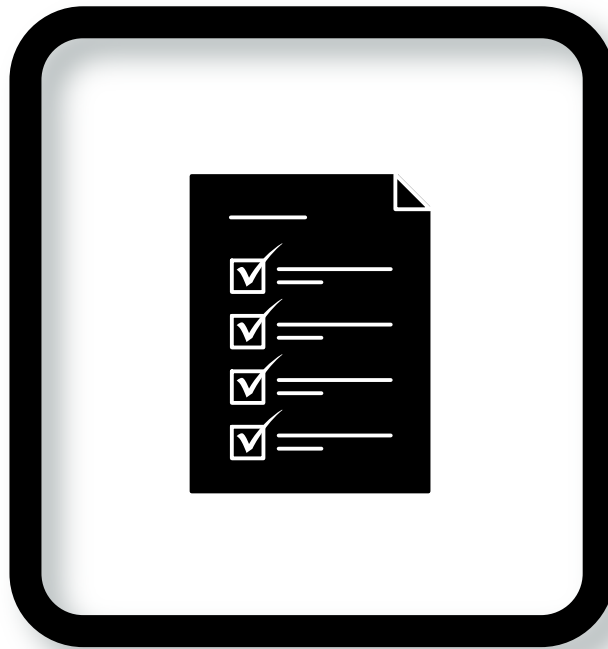

4

VEHICLE FEATURES

The vehicle features listed are standard and optional.

FOLD-DOWN REAR SEAT

The fold-down rear seat is for two additional passengers and increased cargo space.

USB RECEPTACLE

The 5-volt, 2.1-amp USB receptacle supplies electricity to power and charge portable devices. The USB receptacle is not for the movement of data.

The USB receptacle will only operate when a shielded USB cord is connected. When the USB receptacle is not in use, remove the shielded USB cord to prevent battery discharge.

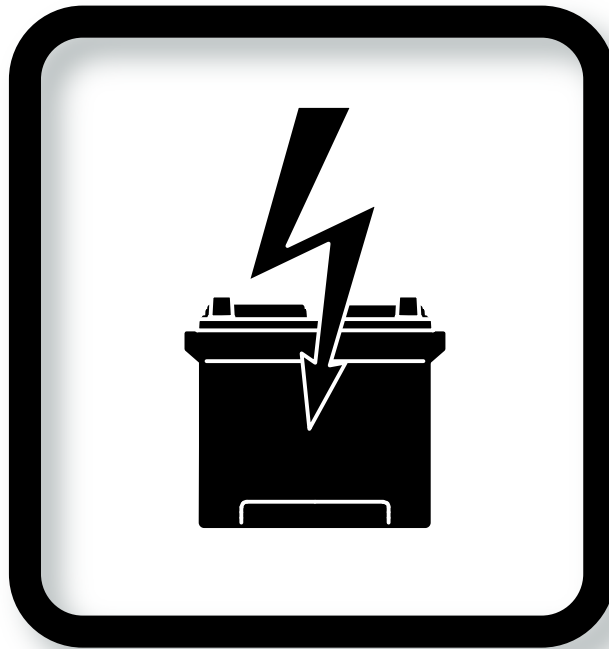

5

BATTERY CHARGER

⚠ DANGER

A BATTERY CHARGER, CORD, PLUG, OR VEHICLE CHARGER RECEPTACLE THAT HAS DAMAGE OR A BAD ELECTRICAL CONNECTION CAN CAUSE A FIRE, PROPERTY DAMAGE, SERIOUS PERSONAL INJURY, OR DEATH. DO NOT CONNECT THE DAMAGED BATTERY CHARGER TO AN AC POWER SOURCE. DO NOT TRY TO REPAIR THE BATTERY CHARGER, CORD, PLUG, OR VEHICLE CHARGER RECEPTACLE. SPEAK WITH YOUR LOCAL DEALER OR DISTRIBUTOR FOR REPAIRS.

⚠ WARNING

INCORRECT CONNECTION OF THE AC CORD CAN CAUSE A FIRE OR AN ELECTRICAL SHOCK. DO NOT USE AN ADAPTER TO CONNECT THE AC CORD INTO A TWO-PRONG POWER SOURCE. CONNECT THE AC CORD TO AN APPROVED POWER SOURCE.

CONNECTION OF THE AC CORD TO AN INCORRECT RECEPTACLE CAN CAUSE A FIRE, ELECTRICAL SHOCK, PROPERTY DAMAGE, SERIOUS PERSONAL INJURY, OR DEATH. CONNECT THE AC CORD TO AN APPROVED POWER SOURCE AND RECEPTACLE.

A BATTERY CHARGER CORD, PLUG, OR VEHICLE CHARGER RECEPTACLE THAT HAS DAMAGE OR A BAD ELECTRICAL CONNECTION CAN CAUSE A FIRE, PROPERTY DAMAGE, SERIOUS PERSONAL INJURY, OR DEATH. DO NOT USE A BATTERY CHARGER THAT HAS DAMAGE, FELL, OR WAS HIT. PUT THE CORDS IN AN AREA TO PREVENT THEM FROM BEING STEPPED ON, TRIPPED OVER, OR SUBJECTED TO DAMAGE OR STRESS. SPEAK WITH YOUR LOCAL DEALER OR DISTRIBUTOR FOR REPAIRS.

LIQUID ON THE BATTERY CHARGER CAN CAUSE PROPERTY DAMAGE, ELECTRICAL SHOCK, SERIOUS PERSONAL INJURY, OR DEATH. DO NOT LET THE BATTERY CHARGER BECOME WET. KEEP THE BATTERY CHARGER DRY.

NOTICE

IF THE BATTERIES ARE REPLACED WITH A DIFFERENT BRAND OR TYPE, BATTERY DAMAGE CAN OCCUR. UPDATE THE BATTERY CHARGER ALGORITHM WHEN A DIFFERENT BRAND OR TYPE OF BATTERY IS INSTALLED. SPEAK WITH YOUR LOCAL APPROVED DEALER OR DISTRIBUTOR TO UPDATE THE BATTERY CHARGER ALGORITHM.

A LIGHTNING STRIKE CAN CAUSE ELECTRICAL COMPONENT DAMAGE. A SURGE ARRESTOR CAN HELP PROTECT ELECTRICAL COMPONENTS. INSTALL A SURGE ARRESTOR ON THE AC CORD.

INTRODUCTION

The Efficient, Reliable, Intelligent, and Connected (ERIC) battery charger is a high-frequency charger that includes many benefits:

EFFICIENT	<ul style="list-style-type: none"> • 93.5% peak, California Energy Commission compliant. • 7.5 maximum AC amperage that lets two chargers operate on one 20-amp circuit. • Automatically checks and charges the batteries. Lets the charger to be connected to the vehicle during extended storage.
RELIABLE	<ul style="list-style-type: none"> • Sealed aluminum housing prevents environmental contaminate damage to internal charger components. • Operates across a wide range of input voltage.
INTELLIGENT	<ul style="list-style-type: none"> • Status indicator lights to identify AC power, state of charge, and faults. • Visual signal when charging starts.
CONNECTED	<ul style="list-style-type: none"> • Two-way data communication through a USB receptacle. • Update the charger with the latest charge algorithm. • Collect status and condition data for charger monitoring.

ERIC IC650 SPECIFICATIONS

MANUFACTURER INFORMATION

Manufacturer	Delta Q Technologies
Model Name	ERIC
Model Number	IC650-048-COMM - with display panel

DIMENSION AND WEIGHT

Dimension	9.9 in (25.1 cm) length 7.3 in (18.5 cm) width 3.1 in (7.9 cm) height
Weight	5.3 lb (2.4 kg)

OPERATIONAL TEMPERATURE

Temperature Range	-40° F to 149° F (-40° C to 65° C)
-------------------	------------------------------------

AC INPUT

Voltage	85 to 270 VAC minimum/maximum 100 to 240 VAC maximum efficiency range
Current	7.5 A maximum
Frequency	50 to 60 Hz

DC OUTPUT

Voltage	48 VDC nominal 72 VDC maximum
Current	13.5 A maximum

GOVERNMENTAL AND INDUSTRY CERTIFICATIONS**EUROPEAN CONFORMITY**

The battery charger is European conformity (CE) certified per EU 2014/30/EU Electromagnetic Compatibility Directive, 2014/35/EU Low Voltage Equipment Directive, 2014/65/EU Restriction of Hazardous Substances Directive, LV Directives EN 60335-1:2012 and EN 60335-2-29:2004, and EMC Directives EN 61000-3-2: 2014, EN 61000-3-3: 2013, EN 61000-6-2: 2005, EN 61000-6-4: 2007.

FEDERAL COMMUNICATIONS COMMISSION

The battery charger is Federal Communications Commission (FCC) certified.

Note: This equipment has been tested and found to comply with the limits for a Class A digital device, pursuant to Part 15 of the FCC Rules. These limits are designed to provide reasonable protection against harmful interference when the equipment is operated in an industrial environment. This equipment generates, uses, and can radiate radio frequency energy and, if not installed and used in accordance with the instruction manual, may cause harmful interference to radio communications. Operation of this equipment in a residential area is likely to cause harmful interference in which case the user will be required to correct the interference at their own expense.

INTERNATIONAL PROTECTION MARKING

The battery charger has an International Protection Marking (IP) certification of IP66.

The battery charger enclosure has an International Protection Marking (IP) certification of IP46.

The battery charger USB receptacle with the dust cover has an International Protection Marking (IP) certification of IP66.

The AC supply connector has an International Protection Marking (IP) certification of IP20.

Note: The AC supply connector is applicable for indoor use only. Keep all AC connections clean and dry.

UNDERWRITERS LABORATORIES AND CANADIAN STANDARDS ASSOCIATION

Listed by Underwriters Laboratories (UL) and Canadian Underwriters. Meets the criteria of the Canadian Standards Association (CSA).

FEATURES

AC ELECTRICAL CORD AND PLUG

The AC electric cord has an equipment-grounding conductor and grounding type plug. The AC plug must be connected to a correctly rated ground fault circuit interrupter (GFCI) receptacle with arc flash protection. The receptacle must be installed and grounded in accordance with the National Electrical Code, local codes, and local ordinances.

Two IC650 battery chargers can be on a single phase branch circuit protected by a 15A circuit breaker or fuse.

 **WARNING**





AN EXTENSION CORD IS NOT RECOMMENDED. INCORRECT CONNECTION OF THE CHARGER AC CORD TO AN EXTENSION CORD CAN CAUSE A FIRE OR AN ELECTRICAL SHOCK.

Use of an extension cord with the charger is not recommended. Precautions when the use of an extension cord is necessary:

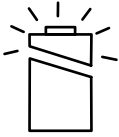
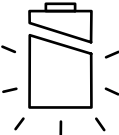

- The extension cord must accept a three-prong plug.
- The extension cord must be as short as possible and not exceed 12 ft (3.7 m).
- The extension cord must be a three-wire No. 12-AWG (American Wire Gauge) or No. 14-SWG (British Standard Wire Gauge).
- Make sure that cords will not be stepped on, tripped over, or subject to damage or stress.

STATUS INDICATOR LIGHTS

The status indicator lights give the AC power availability, charge status, and charger condition.

SYMBOL		STATUS	CONDITION
		Red (Constant)	Charger fault condition. See the display panel for more information.
		Orange (Flash On And Off)	External fault condition. See the display panel for more information.
		Green (Flash On And Off)	The USB receptacle is on. Do not remove the USB flash drive.
		Green (Constant)	Safe to remove the USB flash drive.
		Green (Constant)	Charging is complete. Batteries are fully charged.
		Green (Flash On And Off)	Charging. Batteries are at high state of charge (SOC).
		Green (Constant)	
		Off	Charging. Batteries are not at a high SOC.
		Green (Flash On And Off)	
			Blue (Constant)

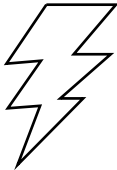
The table below is for battery chargers with a display panel.

SYMBOL	STATUS	CONDITION
	Yellow (Constant)	The charger output is on. There is a risk of electric shock.
Display Panel 	F code	Internal fault condition caused the charge process to stop. Speak with your dealer or distributor.
	E code	External fault condition caused the charge process to stop. Speak with your dealer or distributor.
	P code	The charger program mode is in operation.
	USB code	The USB receptacle is on. Do not remove the USB flash drive.

BATTERY CHARGING INTERLOCK

External Battery Charger: The battery charging interlock is a safety feature that prevents possible damage to the battery charger and vehicle. The battery charging interlock will automatically engage when the DC cord is connected to the vehicle. The vehicle will not operate when the DC cord is connected.

Note: The AC cord does not have to be connected for the battery charging interlock to operate.

Onboard Battery Charger: The battery charging interlock is a safety feature that prevents possible damage to the battery charger and vehicle. The battery charging interlock will automatically engage when the AC cord is connected to a power source. The vehicle will not operate when the AC cord is connected.

EXTERNAL BATTERY CHARGER MOUNTING



IF THE BATTERY CHARGER IS NOT CORRECTLY ATTACHED, IT CAN FALL AND CAUSE PROPERTY DAMAGE AND SERIOUS PERSONAL INJURY. DO NOT HANG THE BATTERY CHARGER BY ITS HANDLE OR CORD. CORRECTLY ATTACH THE BATTERY CHARGER.

Note: This section is applicable to an external battery charger. The onboard battery chargers are installed on the vehicle.

Mount the external battery charger in a position that gives it sufficient airflow and the indicator lights are visible.

A strain relief and drip loop is necessary to prevent damage to the charger. The strain relief prevents tension on the AC plug. The drip loop prevents water damage to the AC plug.

HOW TO MAKE STRAIN RELIEF AND DRIP LOOP

1. Connect the AC cord (1) into the AC plug.

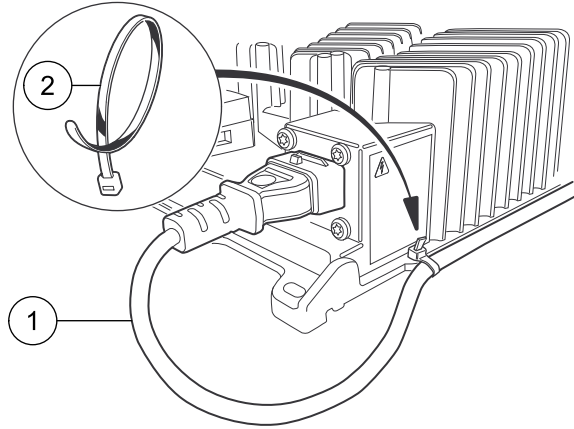

G-130898-000001

2. Supply sufficient AC cord to make a drip loop and strain relief.
3. Secure the AC cord to the battery charger with a plastic cable tie (2).

INSPECTION AND MAINTENANCE

ELECTRICAL CORDS

NOTICE

AN ELECTRICAL SHORT IN THE DC CORD CAN CAUSE THE 30 AMP FUSE TO BLOW. IF THERE IS DAMAGE TO THE DC CORD, SPEAK WITH YOUR LOCAL DEALER OR DISTRIBUTOR.

Examine electrical cords for wear and damage before use. Immediately replace electrical cords for:

- Cracks
- Cuts
- Frayed wiring
- Insulation damage
- Loose connections
- Splices

Make sure that the DC electrical cord has the warning tag attached and that the warning tag is readable. Replace a missing or damaged warning tag immediately.

ELECTRICAL PLUGS AND RECEPTACLES

NOTICE

IF THE PLUG PINS ARE BENT, SPEAK WITH YOUR LOCAL DEALER OR DISTRIBUTOR FOR REPAIRS. DO NOT TRY TO REPAIR THE AC CORD PLUG OR PINS.

Examine electrical plugs for wear and damage before use. Immediately replace electrical plugs for:

- Bent pins

- Corrosion
- Cracks
- Loose connections
- Missing pins
- Worn pins

CLEAN THE ELECTRICAL PLUGS AND RECEPTACLES



LUBRICATING THE PLUG AND RECEPTACLE WITH THE AC CORD CONNECTED TO A POWER SOURCE CAN CAUSE PROPERTY DAMAGE, ELECTRICAL SHOCK, SERIOUS PERSONAL INJURY, AND DEATH. DO NOT LUBRICATE THE PLUG AND VEHICLE CHARGER RECEPTACLE WITH THE AC CORD CONNECTED TO A POWER SOURCE.

1. Disconnect the AC cord from the power source.
2. Disconnect the AC cord from the battery charger.
3. Disconnect the DC cord from the vehicle charger receptacle.
4. Apply electrical contact cleaner to the electrical plugs and receptacles. Refer to the manufacturer instructions.
5. Clean the electrical plugs and receptacles.
6. Lightly lubricate the electrical plugs and receptacles with WD-40®.

BATTERY CHARGER USB RECEPTACLE

The USB receptacle can have intermittent connectivity because of environmental contaminants. Always install the USB dust cover to protect the USB receptacle.

CLEAN THE USB RECEPTACLE

1. Disconnect the DC cord from the vehicle charger receptacle.
2. Disconnect the AC cord from the power source.
3. Carefully remove large contaminants.
4. Use compressed air in short intervals to remove dust and smaller contaminants.
5. Clean the port with a cotton swab and rubbing alcohol or electronics cleaner solvent. Let the alcohol or solvent dry.
6. If contamination continues, apply dielectric grease to the USB receptacle.
7. Install the USB dust cover.

(Page intentionally left blank.)

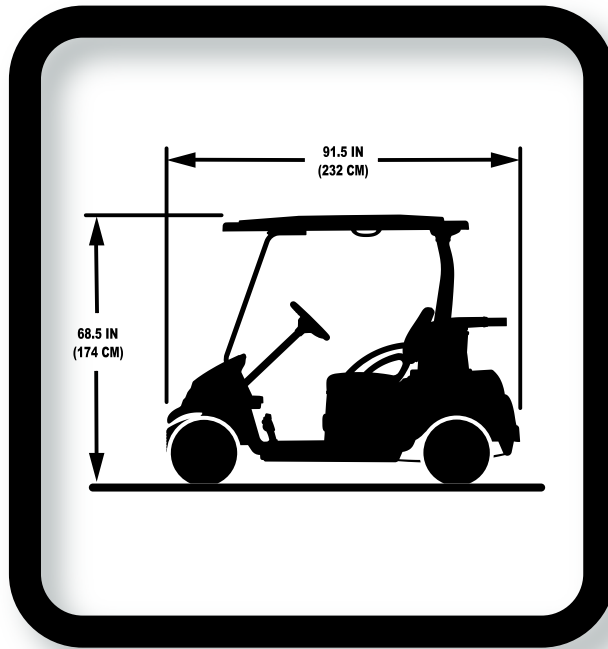

6

VEHICLE SPECIFICATIONS

DIMENSIONS

Length	108 in (274.3 cm)
Width	48.75 in (123.8 cm)
Height	47.5 in (120.6 cm) - at steering wheel 76 in (193 cm) - with canopy
Ground Clearance	4.5 in (11 cm)
Wheel Tread	36 in (91.4 cm) - front wheel 40 in (101.6 cm) - rear wheel
Wheel Base	65.5 in (166 cm)

PERFORMANCE

Forward Speed (On Level Ground)	19 mph (30 km/h)
Turning Radius (SAE J695)	9 ft - 3 in (2.81 m)
Intersecting Aisle Clearance	7 ft - 1 in (2.16 m)
Curb-To-Curb	9 ft - 7 in (2.92 m)
Wall-To-Wall	9 ft - 7 in (2.92 m)
Outside Clearance Circle (Diameter)	17 ft - 6 in (2.28 m)

TIRES

Go to the approved wheel and tire assemblies matrix on <http://www.clubcar.com> for information regarding tire type, inflation pressure, and lugnut torque.

ELECTRIC MOTOR

Motor Type	30V AC motor
Motor Horsepower Rating	4.7 hp (3.5 kW)

BATTERIES

Battery Type	8V high capacity deep cycle flooded lead acid
Battery Quantity	6

NOISE AND VIBRATION

Drive-by Noise Level To Operator (EN 12053–2001)	68.4 dBA (± 2)
Vibration At Driver's Seat (EN 13059–2002)	0.8 (m/s ²) ² (± 0.04)

TRANSAXLE

Fluid Capacity	22 fl-oz (0.67 l)
----------------	-------------------

VEHICLE WEIGHTS AND LOAD CAPACITIES

⚠ WARNING

IF THE RATED CAPACITIES OF THE VEHICLE ARE EXCEEDED, PROPERTY DAMAGE, SERIOUS PERSONAL INJURY, OR DEATH CAN OCCUR. DO NOT EXCEED THE RATED CAPACITY OF THE VEHICLE. RATED CAPACITY IS FOR LEVEL SURFACES ONLY.

TOO MUCH WEIGHT IN THE VEHICLE CAN AFFECT THE VEHICLES HANDLING, OR CAUSE COMPONENT FAILURE, RESULTING IN LOSS OF CONTROL OF VEHICLE AND SERIOUS PERSONAL INJURY. DO NOT EXCEED THE VEHICLE LOAD CAPACITIES.

DO NOT TOW WHEN THE CARGO CAPACITY IS EXCEEDED.

Description	Weight
Vehicle Dry Weight	685 lb (310.8 kg)
Vehicle Curb Weight	1080 lb (489.9 kg)
Maximum Occupant Capacity	800 lb (363 kg)
Maximum Cargo Capacity	Not Applicable
Maximum Trailer Tongue Weight	150 lbf (667 N)
Maximum Gross Trailer Weight	600 lb (272 kg)
Vehicle Rated Capacity	800 lb (363 kg)
Vehicle Combination Rated Capacity	800 lb (363 kg)
Maximum Gross Vehicle Weight	1880 lb (852.8 kg)
Maximum Gross Vehicle Combination Weight	1880 lb (852.8 kg)

TERM	DEFINITION
Vehicle Dry Weight	The vehicle dry weight is the weight of the vehicle with no batteries.
Vehicle Curb Weight	The vehicle curb weight is the weight of the vehicle with the batteries installed.
Maximum Occupant Capacity	The occupant capacity is the maximum permitted weight of occupants to operate the vehicle safely.
Maximum Cargo Capacity	The cargo capacity is the maximum weight of a load that the vehicle can have in the cargo area. The cargo capacity includes the weight of optional equipment.
Maximum Trailer Tongue Weight	The trailer tongue weight is the maximum permitted weight applied by the trailer tongue onto the trailer hitch.
Maximum Gross Trailer Weight	The gross trailer weight is the trailer weight plus the weight of the load on the trailer.
Vehicle Rated Capacity	The vehicle rated capacity is the maximum weight on the vehicle. This capacity includes the weight of: bed load, cargo, occupants, and optional equipment.
Vehicle Combination Rated Capacity	The vehicle combination rated capacity is the maximum weight on the vehicle with a trailer. This capacity includes: vehicle rated capacity and the gross trailer weight.
Maximum Gross Vehicle Weight	The maximum gross vehicle weight is the vehicle weight plus the vehicle rated capacity.
Maximum Gross Vehicle Combination Weight	The maximum gross vehicle combination weight is the maximum gross vehicle weight plus the gross trailer weight.



7

VEHICLE OPERATION

⚠ DANGER

OPERATING THE VEHICLE WHILE OCCUPANTS ARE NOT FULLY SEATED CAN CAUSE SERIOUS PERSONAL INJURY OR DEATH. START THE VEHICLE ONLY WHEN ALL OCCUPANTS ARE FULLY SEATED.

FALLING OBJECTS CAN CAUSE PROPERTY DAMAGE, SERIOUS PERSONAL INJURY, OR DEATH. DO NOT OPERATE THE VEHICLE WHERE THERE IS A RISK OF FALLING OBJECTS.

DO NOT LET A PASSENGER HOLD A CHILD ON THEIR LAP WHILE THE VEHICLE IS IN OPERATION.

DO NOT LET PASSENGERS RIDE IN THE VEHICLE OR TRAILER BEING TOWED.

⚠ WARNING

KEEP AWAY FROM DROP-OFFS, STEEP SLOPES, AND UNSTABLE SURFACES.

THE VEHICLE IS NOT DESIGNED TO BE USED ON PUBLIC ROADS. DO NOT LICENSE THE VEHICLE FOR PUBLIC ROADS. DO NOT OPERATOR THE VEHICLE ON PUBLIC ROADS.

SUDDEN STARTS, STOPS, AND TURNS CAN CAUSE PROPERTY DAMAGE AND SERIOUS PERSONAL INJURY. PREVENT SUDDEN STARTS, STOPS, AND TURNS.

FAILURE TO CORRECTLY MAINTAIN THE VEHICLE AND MAKE NECESSARY REPAIRS CAN DECREASE VEHICLE PERFORMANCE, CAUSE A FIRE, PROPERTY DAMAGE, SERIOUS PERSONAL INJURY, OR DEATH. IF PROBLEMS ARE FOUND DURING SCHEDULED INSPECTION OR SERVICE, OPERATE THE VEHICLE ONLY WHEN REPAIRS ARE MADE.

MAKE SURE THAT ALL PASSENGERS CAN SECURE THEMSELVES IN THE VEHICLE BEFORE VEHICLE OPERATION.

TO PREVENT SERIOUS PERSONAL INJURY, KEEP ENTIRE BODY IN THE VEHICLE DURING OPERATION.

THE VEHICLE IS NOT SPECIALLY EQUIPPED FOR HANDICAPPED PERSONS. BEFORE VEHICLE OPERATION, MAKE SURE THAT ALL PERSONS COMPLY WITH THE WARNINGS AND OPERATING INSTRUCTIONS.

INCORRECT OPERATION OF THE VEHICLE CAN CAUSE DECREASED VEHICLE PERFORMANCE, PROPERTY DAMAGE, SERIOUS PERSONAL INJURY, OR DEATH.

TO PREVENT FALLS FROM THE VEHICLE, PASSENGERS MUST STAY SEATED AND ALWAYS HOLD ON TO HAND HOLDS OR HANDRAILS WHEN THE VEHICLE IS IN OPERATION. THE DRIVER MUST KEEP BOTH HANDS ON THE STEERING WHEEL WHEN THE VEHICLE IS IN OPERATION.

A SHARP TURN AT HIGH SPEEDS CAN CAUSE A ROLL-OVER, FALL, PROPERTY DAMAGE, AND SERIOUS PERSONAL INJURY. OPERATE THE VEHICLE SLOWLY IN TURNS.

UNINTENDED VEHICLE OPERATION CAN CAUSE SERIOUS PERSONAL INJURY OR DEATH. BEFORE LEAVING THE VEHICLE OR DURING VEHICLE MAINTENANCE, DISABLE THE VEHICLE.

THE VEHICLE IS NOT DESIGNED TO MEET CHILD SAFETY SEAT COMPATIBILITY REQUIREMENTS. CHILDREN REQUIRING A CHILD SAFETY SEAT MUST NOT RIDE ON THE VEHICLE. COMPLY WITH STATE AND LOCAL LAWS PERTAINING TO CHILD SAFETY.

THIS VEHICLE IS NOT INTENDED FOR USE BY PERSONS, INCLUDING CHILDREN, WITH REDUCED PHYSICAL, SENSORY OR MENTAL CAPABILITIES, OR LACK OF EXPERIENCE AND KNOWLEDGE, UNLESS THEY HAVE BEEN GIVEN SUPERVISION OR INSTRUCTION CONCERNING USE OF THE VEHICLE BY A PERSON RESPONSIBLE FOR THEIR SAFETY. CHILDREN SHOULD BE SUPERVISED TO ENSURE THAT THEY DO NOT PLAY WITH THE VEHICLE.

 **CAUTION**

OPERATE THE VEHICLE ONLY FROM THE DRIVERS SEAT.

OPERATE THE VEHICLE ONLY IN SPECIFIED AREAS.

ONLY AN AUTHORIZED LICENSED DRIVER CAN OPERATE THE VEHICLE.

ONLY OPERATE THE VEHICLE IN COMPLIANCE WITH LOCAL AND STATE LAWS.

USE CAUTION WHEN OPERATING THE VEHICLE IN THE PRESENCE OF HIGHER-SPEED VEHICLES, IN CONGESTED AREAS, OR ON UNIMPROVED SURFACES.

DAILY PRE-OPERATIONAL SAFETY AND PERFORMANCE CHECKS

OVERVIEW

Use the daily pre-operational checklist and vehicle performance inspection to inspect the operational condition and performance of the vehicle.

If a vehicle is found to be in bad operational condition, remove it from operation. Removal from operation will prevent more damage to the vehicle and prevent a serious injury.

If the vehicle is removed from operation, speak with your dealer or distributor for maintenance and repairs.

DAILY PRE-OPERATIONAL SAFETY CHECKLIST

INSPECTION AREA	INSPECTION CRITERIA
General	<ul style="list-style-type: none"> • Make sure that all parts are correctly installed. • Make sure that all nuts, bolts, and screws are tight. • Replace missing, worn, or damaged items.
Decals	<ul style="list-style-type: none"> • Make sure all safety, regulatory, and marketing decals are correctly installed. • Clean the decals with a soft moist cloth. • Replace missing, worn, or damaged decals.
Tires	<ul style="list-style-type: none"> • Examine for wear and damage. • Replace worn or damaged tires. • Make sure that the tire pressure is correct.
Batteries	<ul style="list-style-type: none"> • Make sure that all battery hold-downs are tight. • Make sure that the battery cables are correctly attached. Tighten as necessary. • Examine the battery posts for corrosion. If corrosion is found, remove the corrosion. • Make sure that the batteries are fully charged. • Examine the battery acid level. Add deionized or distilled water as necessary. • Replace missing, worn, or damaged items.
Battery Charger	<ul style="list-style-type: none"> • Examine the electrical cords for cracks, loose connections, and frayed wires. • Examine receptacle contacts and plug terminals. Clean as necessary. • Replace missing, worn, or damaged items. • Make sure that the battery charger operates correctly.
Vehicle Performance Inspection	<ul style="list-style-type: none"> • Do a vehicle performance inspection.

VEHICLE PERFORMANCE INSPECTION

Before the vehicle performance inspection:

- Read and obey all safety decals and information located on the vehicle.
- Understand how to operate the vehicle correctly and safely.

- Understand the function of all vehicle controls, indicators, displays, and gauges.
- Front wheels are turned in the direction of travel.
- No obstructions are in the vehicle's path.

During the vehicle performance inspection:

- Listen for unusual noises such as squeaks or rattles.
- Examine the ride and performance of the vehicle.
- Examine the steering. The vehicle must be easy to steer and must not have play in the steering wheel.
- The vehicle must stop smooth and straight. The brake pedal must not be able to be pushed to the floorboard. Have a trained technician do a brake system check if:
 - The vehicle swerves.
 - The brake pedal goes more than half the distance to the floorboard with moderate pressure applied.
 - The vehicle does not stop.

To do the vehicle performance inspection:

1. Turn the key to ON.
2. Push and hold the brake pedal.
3. Set the Forward / Neutral / Reverse control (FNR) to R. Make sure that the multi-purpose buzzer operates.
4. Release the brake pedal.
5. Slowly push the accelerator pedal. Make sure the vehicle moves in reverse.
6. Slowly push the brake pedal. Stop the vehicle.
7. Set the FNR to F. Make sure that the multi-purpose buzzer does not operate.
8. Release the brake pedal.
9. Slowly push the accelerator pedal. Make sure that the vehicle moves forward.
10. Operate the vehicle to full speed.
11. Release the accelerator pedal. Make sure:
 - 11.A The accelerator pedal goes back to its initial position.
 - 11.B Make sure that the regenerative braking functions normally.
12. Slowly push the brake pedal. Stop the vehicle.
13. Park the vehicle on a level surface.
14. Disengage the park brake.
15. Try to push the vehicle to engage the walk-away braking. Walk-away braking is engaged when:
 - 15.A The multi-purpose buzzer operates.

Note: Regenerative braking operates and limits the vehicle speed to no more than 1 to 3 mph (1.6 to 4.8 km/h).
16. Stop the vehicle.

17. Park the vehicle on a grade of 20% or less. Make sure that the park brake holds the vehicles position.
18. Slowly push the accelerator pedal. Increase the vehicle to maximum speed down a grade of 20% or less.
19. Make sure regenerative braking engages at the maximum programmed speed and limits the vehicle to its maximum programmed speed.
20. Slowly push the brake pedal. Stop the vehicle. Make sure regenerative braking disengages when the vehicle speed is below the maximum programmed top speed.

VEHICLE MOVEMENT

OVERVIEW

Operate the vehicle only after you read, understand, and know:

- The Driving Instructions
- Indicators
- Gauges
- Displays
- Controls

MOTOR START

Before motor start:

- Read and obey all safety decals and information located on the vehicle.
- Understand how to operate the vehicle correctly and safely.
- Understand the function of all vehicle controls, indicators, displays, and gauges.
- Make sure that all passengers are seated and use the hand holds or handrails. The operator must have both hands on the steering wheel.
- Front wheels are turned in the direction of travel.
- No obstructions are in the vehicle's path.
- Forward / Neutral / Reverse control (FNR) is set to N.
- The park brake is set.
- The accelerator pedal is not pushed.
- The vehicle is at a full stop.

To start the motor:

1. Put the key into the key switch.
2. Turn the key to ON. Push the accelerator pedal to start the motor.

TURN OFF MOTOR

1. Release the accelerator pedal.
2. Stop the vehicle.

3. Push and hold the brake pedal.
4. Set the Forward / Neutral / Reverse control (FNR) to N.
5. Turn the key to OFF.
6. Engage the park brake to lock the wheels.
7. Remove the key. Keep the key in a safe area.

FORWARD MOVEMENT

 **WARNING**

FAILURE TO DECREASE THE VEHICLE SPEED IN BAD DRIVING CONDITIONS CAN CAUSE PROPERTY DAMAGE, SERIOUS PERSONAL INJURY, OR DEATH. DECREASE THE VEHICLE SPEED WHEN IN BAD DRIVING CONDITIONS SUCH AS WET GRASS OR ROUGH TERRAIN.

Before forward movement:

- Read and obey all safety decals and information located on the vehicle.
- Understand how to operate the vehicle correctly and safely.
- Understand the function of all vehicle controls, indicators, displays, and gauges.
- Make sure that all passengers are seated with seat belts fastened (if equipped) and use the hand holds or handrails. The operator must have both hands on the steering wheel.
- Make sure that the front wheels are turned in the direction of travel.
- Make sure that there are no obstructions in the vehicle's path.
- The key switch is set to ON.
- The vehicle is at a full stop.

To move the vehicle forward:

1. Set the Forward / Neutral / Reverse control (FNR) to F.
2. Disengage the park brake.
3. Slowly push the accelerator pedal.

REVERSE MOVEMENT

 **WARNING**

FAILURE TO DECREASE THE VEHICLE SPEED WHEN IN REVERSE CAN CAUSE PROPERTY DAMAGE, SERIOUS PERSONAL INJURY, OR DEATH. DECREASE THE VEHICLE SPEED WHEN IN REVERSE AND PREVENT SUDDEN STOPS.

Before reverse movement:

- Read and obey all safety decals and information located on the vehicle.
- Understand how to operate the vehicle correctly and safely.
- Understand the function of all vehicle controls, indicators, displays, and gauges.

- Make sure that all passengers are seated with seat belts fastened (if equipped) and use the hand holds or handrails. The operator must have both hands on the steering wheel.
- Make sure that the front wheels are turned in the direction of travel.
- Make sure that there are no obstructions are in the vehicles path.
- The key switch is set to ON.
- The vehicle is at a full stop.

To move the vehicle in reverse:

1. Set the Forward / Neutral / Reverse control (FNR) to R. Make sure that the multi-purpose buzzer operates.
2. Disengage the park brake.
3. Slowly push the accelerator pedal.

SLOW OR STOP THE VEHICLE

1. Release the accelerator pedal.
2. Push the brake pedal.

PARK THE VEHICLE

1. Stop the vehicle.
2. Engage the park brake to prevent vehicle movement.
3. Set the Forward / Neutral / Reverse control (FNR) to N.
4. Turn the key to OFF.
5. Remove the key. Keep the key in a safe area.

DRIVING CONDITIONS

UNPAVED SURFACES

Precautions for operation on unpaved or unimproved surfaces:

- Decrease vehicle speed.
- Use extreme caution.

UPHILL SLOPE



VEHICLE ROLL-OVER CAN CAUSE SERIOUS PERSONAL INJURY OR DEATH. PREVENT STOPPING ON A HILL WHEN TOWING OR WITH A LOADED VEHICLE. IF A VEHICLE WITH A LOAD IS STOPPED ON A HILL, PREVENT SUDDEN STARTS, ROLLING BACKWARD, AND SUDDEN STOPS.

DO NOT USE THE ACCELERATOR PEDAL TO HOLD THE VEHICLE POSITION ON A SLOPE. WHEN STOPPED ON A SLOPE, USE THE BRAKE PEDAL TO HOLD THE VEHICLE POSITION.

TO PREVENT ROLL-OVER, OPERATE THE VEHICLE SLOWLY STRAIGHT UP AND DOWN SLOPES. DO NOT OPERATE THE VEHICLE ON SLOPES THAT ARE MORE THAN A 20% GRADE.

VEHICLE ROLLBACK WHEN STARTING ON AN INCLINE CAN CAUSE PROPERTY DAMAGE, SERIOUS PERSONAL INJURY, OR DEATH. USE THE BRAKE PEDAL TO HOLD THE VEHICLE UNTIL THE DRIVETRAIN IS FULLY ENGAGED.

Precautions when on an uphill slope:

- Prevent driving on slopes that exceed 20% grade.
- Always examine the terrain carefully before driving on a slope. Do not drive on a slope with slippery or loose surfaces.
- Keep your feet on the floorboard.
- Drive in a straight line on the slope.
- Prevent driving at an offset angle. An offset angle will cause the vehicle to lean sharply to one side.
- Continue at a stable rate of speed. Do not accelerate quickly.
- Do not stop a vehicle with a load on a slope. If a vehicle with a load must stop on a slope, prevent backwards movement or sudden starts or stops.
- Do not go over the top of a hill at high speed. Obstacles, sharp drop-offs, other vehicles, or persons could be on the other side of the hill.

SIDE HILL SLOPE



TO PREVENT ROLL-OVER, PROPERTY DAMAGE, AND SERIOUS PERSONAL INJURY, OPERATE THE VEHICLE SLOWLY ON A SLOPE.

VEHICLE ROLLBACK WHEN STARTING ON AN INCLINE CAN CAUSE PROPERTY DAMAGE, SERIOUS PERSONAL INJURY, OR DEATH. USE THE BRAKE PEDAL TO HOLD THE VEHICLE UNTIL THE DRIVETRAIN IS FULLY ENGAGED.

Vehicle operation on a side hill slope is not recommended.

Precautions if driving on a side hill slope is unavoidable:

- Prevent driving on slopes that exceed 10% grade.
- Decrease vehicle speed.
- Use extreme caution.
- Always examine the terrain carefully before driving on a slope. Do not drive on a slope with slippery or loose surfaces.
- Keep your feet on the floorboard.
- Continue at a stable rate of speed. Do not accelerate quickly.

DOWNHILL SLOPE



VEHICLE ROLL-OVER CAN CAUSE SERIOUS PERSONAL INJURY OR DEATH. PREVENT STOPPING ON A HILL WHEN TOWING OR WITH A LOADED VEHICLE. IF A VEHICLE WITH A LOAD IS STOPPED ON A HILL, PREVENT SUDDEN STARTS, ROLLING BACKWARD, AND SUDDEN STOPS.

TO PREVENT ROLL-OVER, OPERATE THE VEHICLE SLOWLY STRAIGHT UP AND DOWN SLOPES. DO NOT OPERATE THE VEHICLE ON SLOPES THAT ARE MORE THAN A 20% GRADE.

USE THE BRAKE PEDAL TO CONTROL THE VEHICLE SPEED WHEN DRIVING DOWN A SLOPE.

THE OPERATOR MUST CONTROL THE VEHICLE SPEED WHEN GOING DOWN A SLOPE.

VEHICLE ROLLBACK WHEN STARTING ON AN INCLINE CAN CAUSE PROPERTY DAMAGE, SERIOUS PERSONAL INJURY, OR DEATH. USE THE BRAKE PEDAL TO HOLD THE VEHICLE UNTIL THE DRIVETRAIN IS FULLY ENGAGED.

Precautions when on a downhill slope:

- Prevent driving on slopes that exceed 20% grade.
- Always examine the terrain carefully before driving on a slope. Do not drive on a slope with slippery or loose surfaces.
- Keep the heavy end of the vehicle uphill.
- Keep your feet on the floorboard.
- Drive in a straight line on the slope.
- Prevent driving at an offset angle. An offset angle will cause the vehicle to lean sharply to one side.
- Continue at a stable rate of speed. Do not accelerate quickly.
- Decrease the vehicle speed.
- Push the brake pedal gradually to slow the vehicle.

OVER OBSTACLES

Driving over obstacles is not recommended and should be avoided.

Precautions if driving over obstacles is unavoidable:

- Always examine the terrain for obstacles before driving in a new area.
- Look forward and learn to read the terrain. Be constantly alert for hazards.
- Drive slowly and use caution when operating on unfamiliar terrain. Not all obstacles are immediately visible.
- Do not drive over large obstacles such as large rocks and fallen trees.

BELOW OBSTACLES



DO NOT OPERATE THE VEHICLE BELOW OBJECTS WITH A HEIGHT THAT IS LESS THAN THE HEIGHT OF THE VEHICLE.

Driving below obstacles is not recommended.

Precautions if operation below obstacles is unavoidable:

- Always examine the terrain for obstacles before driving in a new area.
- Look forward and learn to read the terrain. Be constantly alert for low hanging obstacles such as tree limbs.

- Drive slowly and use caution when operating on unfamiliar terrain. Not all obstacles are immediately visible.

NIGHT TIME

 **DANGER**

OPERATING THE VEHICLE AT NIGHT WITHOUT THE CORRECT EQUIPMENT CAN CAUSE PROPERTY DAMAGE, SERIOUS PERSONAL INJURY, OR DEATH. TO OPERATE THE VEHICLE AT NIGHT, THE VEHICLE MUST HAVE HEADLIGHTS, TAILLIGHTS, AND REFLECTORS.

Vehicle operation at night is not recommended. When driving at night is unavoidable, the vehicle must have:

- Headlights
- Taillights
- Reflectors

Precautions if driving at night is unavoidable:

- Always have headlights on.
- Always examine the terrain for obstacles before driving in a new area.
- Look forward and learn to read the terrain. Be constantly alert for hazards.
- Drive slowly and use caution when operating on unfamiliar terrain. Not all obstacles are immediately visible.

THROUGH WATER

 **WARNING**

DRIVING THROUGH WATER CAN DECREASE BRAKE PERFORMANCE. AFTER DRIVING THROUGH WATER, LIGHTLY PUSH THE BRAKE PEDAL TO CHECK THE BRAKE PERFORMANCE. IF THE VEHICLE SPEED DOES NOT DECREASE AT A NORMAL RATE, CONTINUE TO PUSH THE BRAKE PEDAL UNTIL THE BRAKE PERFORMANCE IS BACK TO NORMAL.

Vehicle operation through water is not recommended and should be avoided.

Precautions when driving through water is unavoidable:

- Decrease the vehicle speed.
- Use extreme caution.
- Do not drive through water that is more than 3 inches (7.62 cm) deep.

WITH CARGO

 **WARNING**

BEFORE A LOAD IS PUT IN THE VEHICLE, ENGAGE PARK BRAKE TO LOCK THE WHEELS.

 **CAUTION**

THE CARGO IN THE VEHICLE CAN MOVE AND AFFECT THE HANDLING, STEERING, AND BRAKES. DO NOT HAVE TOP HEAVY LOADS. SECURE THE CARGO. REDUCE THE SPEED OF THE VEHICLE AND TURN SLOW.

Hauling cargo incorrectly can change the vehicles handling and may cause loss of control or brake instability, which can cause serious injury or death.

Precautions when operating with cargo:

- Always read and understand the load distribution warnings listed on the safety labels. The total load (operator, passenger, accessories, cargo and weight on hitch) must not exceed the maximum weight capacity of the vehicle. Do not exceed the published capacities.
- Do not exceed the maximum weight capacity of the vehicle. When determining added weight to the vehicle, include the weight of the operator, passenger, accessories, loads in the rack or box and the load on the trailer tongue. The combined weight of these items must not exceed the maximum weight capacity.
- Keep the heavy end of the vehicle uphill.
- Always load the cargo box with the load as far forward and as low as possible.
- Always operate the vehicle with extreme caution when hauling or towing loads.
- Secure all loads before operating. Unsecured loads can cause unstable operating conditions, which could cause loss of vehicle control.
- Operate only with stable and safely arranged loads. When handling off-centered loads that cannot be centered, correctly fasten the load and operate with extra caution. Always attach the tow load to the hitch point designated for the vehicle.
- Heavy loads can cause braking and control problems. Use extreme caution when applying brakes with a loaded vehicle. Avoid terrain or situations that may require backing downhill. Use extreme caution when operating with loads that extend over the rack sides.
- Stability and maneuverability may be adversely affected, causing a roll over.
- Slow down and drive in the lowest gear available.
- Decrease speed and allow a greater distance for breaking when hauling cargo.
- When operating over rough or hilly terrain, decrease speed and cargo to maintain stable driving conditions.
- Do not move faster than the recommended speeds. Vehicle should never exceed 10 mph (16 km/h) while towing a load on a level grass surface. Vehicle speed should never exceed 5 mph (8 km/h) when towing loads in rough terrain, while cornering, or while climbing or going down a hill.



8

VEHICLE MAINTENANCE

⚠ DANGER

A WHEEL OR TIRE THAT HAS DAMAGE CAN CAUSE PROPERTY DAMAGE, SERIOUS PERSONAL INJURY, OR DEATH. DO NOT TRY TO REPAIR A WHEEL OR TIRE. SPEAK WITH YOUR LOCAL DEALER OR DISTRIBUTOR FOR REPAIRS.

⚠ WARNING

UNINTENDED VEHICLE OPERATION CAN CAUSE SERIOUS PERSONAL INJURY OR DEATH. BEFORE LEAVING THE VEHICLE OR DURING VEHICLE MAINTENANCE, DISABLE THE VEHICLE.

ONLY TRAINED TECHNICIANS SHOULD SERVICE OR REPAIR THE VEHICLE. ANYONE DOING EVEN SIMPLE REPAIRS OR SERVICE SHOULD HAVE KNOWLEDGE AND EXPERIENCE IN ELECTRICAL AND MECHANICAL REPAIR. THE APPROPRIATE INSTRUCTIONS MUST BE USED WHEN PERFORMING MAINTENANCE, SERVICE, OR ACCESSORY INSTALLATION.

FAILURE TO CORRECTLY MAINTAIN THE VEHICLE AND MAKE NECESSARY REPAIRS CAN DECREASE VEHICLE PERFORMANCE, CAUSE A FIRE, PROPERTY DAMAGE, SERIOUS PERSONAL INJURY, OR DEATH. IF PROBLEMS ARE FOUND DURING SCHEDULED INSPECTION OR SERVICE, OPERATE THE VEHICLE ONLY WHEN REPAIRS ARE MADE.

UNINTENTIONAL VEHICLE STARTUP CAN CAUSE A FIRE, PROPERTY DAMAGE, OR SERIOUS PERSONAL INJURY. SET THE RUN/TOW SWITCH TO TOW. DISCONNECT THE BATTERIES. WAIT 90 SECONDS FOR THE CONTROLLER DISCHARGE.

DO NOT WORK ON THE VEHICLE POWERTRAIN WHEN THE VEHICLE IS LOADED.

DO NOT WEAR LOOSE CLOTHING OR JEWELRY SUCH AS RINGS, WATCHES, CHAINS, ETC., WHEN SERVICING THE VEHICLE OR BATTERY CHARGER.

LIFT ONLY ONE END OF THE VEHICLE AT A TIME. USE A SUITABLE LIFTING DEVICE WITH 1000 LB (454 KG) MINIMUM LIFTING CAPACITY. DO NOT USE THE LIFTING DEVICE TO HOLD THE VEHICLE IN THE LIFTED POSITION. USE APPROVED JACK STANDS OF PROPER WEIGHT CAPACITY TO SUPPORT THE VEHICLE AND CHOCK THE WHEELS THAT REMAIN ON THE FLOOR.

IF WIRES ARE REMOVED OR REPLACED, MAKE SURE THAT THE WIRING AND WIRE HARNESS ARE CORRECTLY ROUTED AND ATTACHED. FAILURE TO CORRECTLY ROUTE AND ATTACH THE WIRING COULD RESULT IN VEHICLE MALFUNCTION, PROPERTY DAMAGE, SERIOUS PERSONAL INJURY, OR DEATH.

⚠ CAUTION

WEAR SAFETY GLASSES OR APPROVED EYE PROTECTION WHEN YOU DO THE SERVICING OF THE VEHICLE. WEAR A FULL FACE SHIELD AND RUBBER GLOVES WHEN NEAR BATTERIES.

DISABLE THE VEHICLE

⚠ WARNING

UNINTENDED VEHICLE OPERATION CAN CAUSE SERIOUS PERSONAL INJURY OR DEATH. BEFORE LEAVING THE VEHICLE OR DURING VEHICLE MAINTENANCE, DISABLE THE VEHICLE.

1. Park the vehicle on a solid level surface.
2. Engage the park brake to prevent vehicle movement.
3. Turn the key to OFF.
4. Remove the key.
5. Set the Forward / Neutral / Reverse control (FNR) to N.
6. Put the chocks against the wheels.

VEHICLE CLEANING

CLEANING THE WINDSHIELD

Use a soft towel and water to clean the windshield. Use mild soap as necessary. Do not use a household window cleaner.

CLEANING THE VEHICLE EXTERIOR

NOTICE

MOISTURE CAN CAUSE ELECTRICAL COMPONENT DAMAGE. DO NOT USE A PRESSURE WASHER OR STEAM CLEANER TO CLEAN THE VEHICLE.

Use only commercially available automotive cleaners with a sponge or soft cloth for normal cleaning. A garden hose at normal residential water pressure is sufficient.

Use a commercially available aluminum cleaner paste and fine grade (No. 00) steel wool to remove oxidation or discoloration from aluminum.

Use non-abrasive wax products. Battery acid, fertilizers, tars, asphalt, creosote, paint, or chewing gum should be removed immediately to prevent possible stains.

Discard the waste water correctly.

CLEANING THE VEHICLE INTERIOR

NOTICE

MOISTURE CAN CAUSE ELECTRICAL COMPONENT DAMAGE. DO NOT USE A PRESSURE WASHER OR STEAM CLEANER TO CLEAN THE VEHICLE.

The seats of the vehicle will last longer with proper cleaning. Use a solution of 10% liquid soap and warm water applied with a soft cloth. Use a soft bristle brush to remove embedded dirt.

Discard the waste water correctly.

MAINTENANCE SCHEDULE

MAINTENANCE SCHEDULE OVERVIEW

A preventive maintenance program with regular maintenance can prevent excessive vehicle downtime and repair costs. Use these items to keep the vehicle in proper working condition.

- Daily Pre-Operation Safety Checklist
- Vehicle Performance Inspection
- Maintenance Service Schedule

If a vehicle is found to be in bad operational condition, remove it from operation. Removal from operation will prevent more damage to the vehicle and prevent the possible injury because of dangerous conditions.

Speak with your dealer or distributor for maintenance and repairs.

MAINTENANCE SERVICE SCHEDULE

Note: The Maintenance Service Schedule must be done more frequently on vehicles that are constantly subjected to heavy use or severe operating conditions.

INTERVAL	DESCRIPTION
Initial: 6 weeks	Single Point Watering System (SPWS): Establish a watering interval. SPWS: Make sure the valves operate correctly. Examine the battery acid level of all the batteries. Add water if necessary.
Daily	Do the Daily Pre-Operational Safety Check. Do the Daily Vehicle Performance Inspection.
	Charge the batteries.
Weekly	No SPWS: Examine the battery acid level of all the batteries. Add water as necessary.
Monthly	Examine the tire pressure.
	Clean the vehicle.
	Batteries: <ul style="list-style-type: none"> • SPWS: Add water to the batteries. • Clean the batteries. • Clean the battery compartment. • Make sure the battery cables are tight. • Make sure the battery hold-downs are tight.
Quarterly	Do an inspection of the deionizer. Do an inspection of the SPWS.

INTERVAL	DESCRIPTION
<p>50 hours / 6 months</p>	<p>Use WD-40® to lubricate the battery charger receptacle.</p>
	<p>Have a trained technician:</p> <ul style="list-style-type: none"> • examine and lubricate the brake system • examine the electrical system • examine the front wheel alignment • lubricate the front suspension • examine the Motor Controller Output Regulator (MCOR)
<p>100 hours / 12 months</p>	<p>Have a trained technician examine the:</p> <ul style="list-style-type: none"> • pedal components • transaxle fluid • batteries • safety decals

MAINTENANCE TASKS

LIFT THE VEHICLE

LIFT THE FRONT OF THE VEHICLE



LIFTING THE VEHICLE WITH CARGO CAN CAUSE PROPERTY DAMAGE, SERIOUS PERSONAL INJURY, OR DEATH. REMOVE ALL CARGO FROM THE CARGO BED BEFORE THE VEHICLE IS LIFTED.

Before the vehicle is lifted:

- Disable the vehicle.
- Disconnect the batteries.
- Use a jack and jack stands rated for the vehicle.

To lift the front of the vehicle:

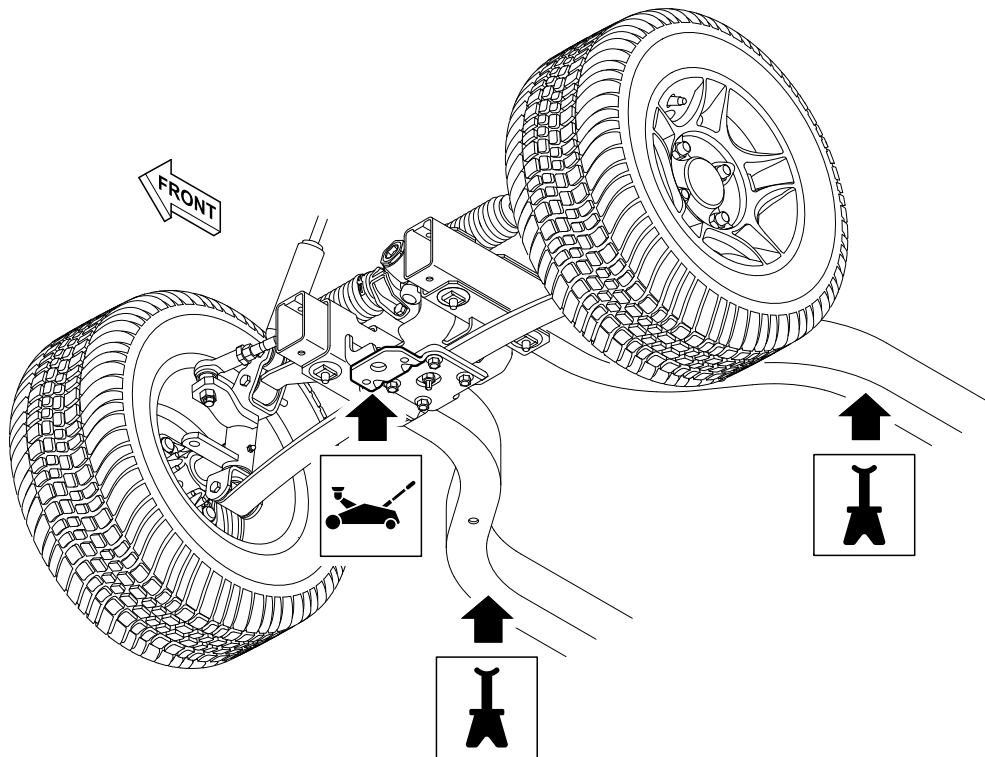

1. Place the jack in the center of the lift point.
2. Lift the front of the vehicle.
3. Put jack stands under the frame rails.
4. Lower the vehicle onto the jack stands.

LIFT THE REAR OF THE VEHICLE

⚠ WARNING

LIFTING THE VEHICLE WITH CARGO CAN CAUSE PROPERTY DAMAGE, SERIOUS PERSONAL INJURY, OR DEATH. REMOVE ALL CARGO FROM THE CARGO BED BEFORE THE VEHICLE IS LIFTED.

Before the vehicle is lifted:

- Disable the vehicle.
- Disconnect the batteries.
- Use a jack and jack stands rated for the vehicle.

To lift the rear of the vehicle:

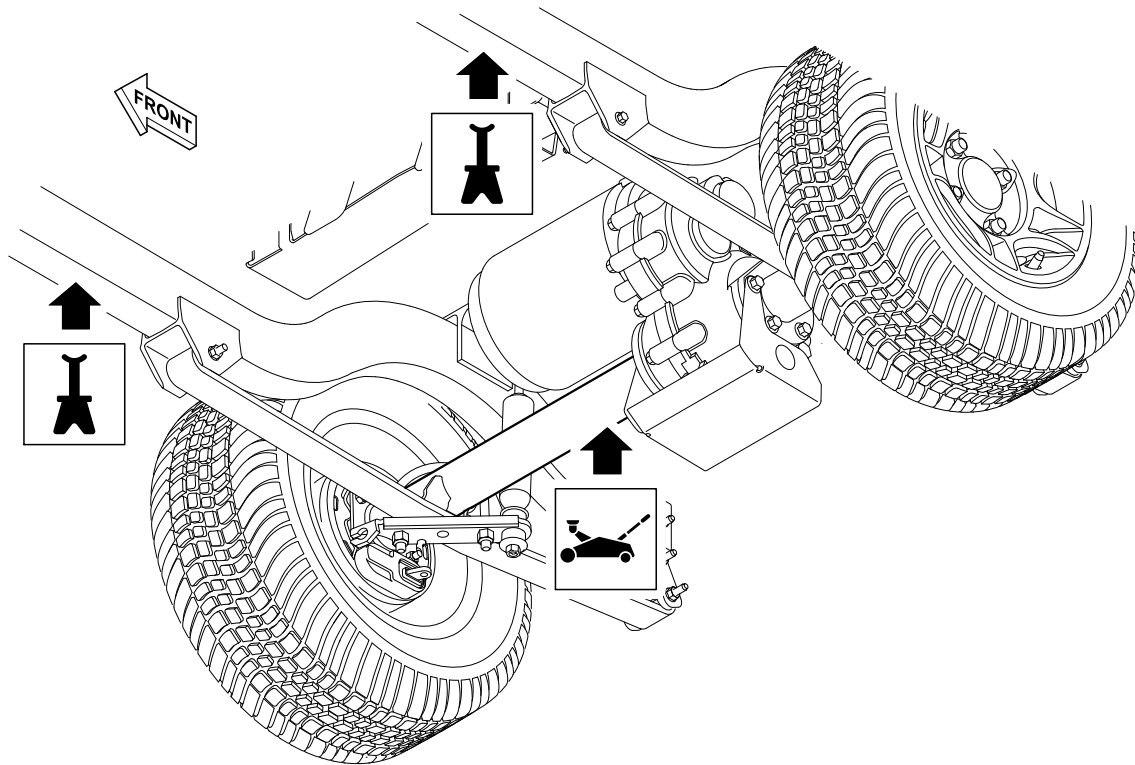

1. Place the jack in the center of the lift point.
2. Lift the rear of the vehicle.
3. Put jack stands under the frame rails.
4. Lower the vehicle onto the jack stands.

LOWER THE VEHICLE

LOWER THE FRONT OF THE VEHICLE

Before the front of the vehicle is lowered:

- Use a jack rated for the vehicle.

To lower the front of the vehicle:

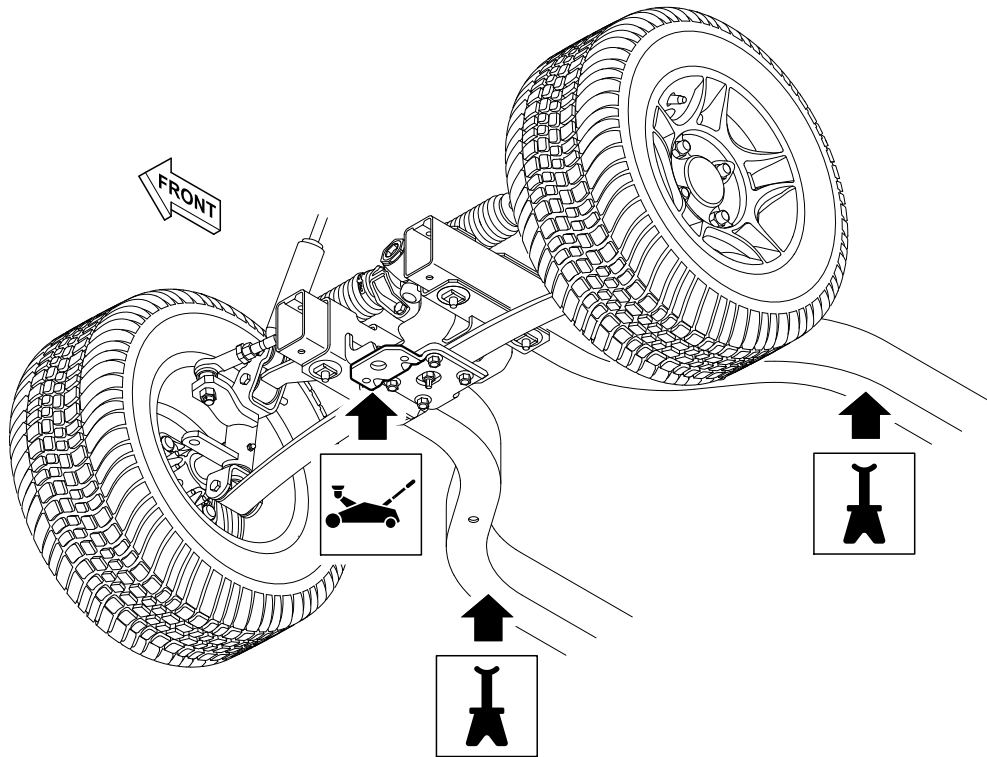

1. Place the jack in the center of the lift point.
2. Lift the vehicle off of the jack stands.
3. Remove the jack stands.
4. Lower the vehicle.

LOWER THE REAR OF THE VEHICLE

Before the rear of the vehicle is lowered:

- Use a jack rated for the vehicle.

To lower the rear of the vehicle:

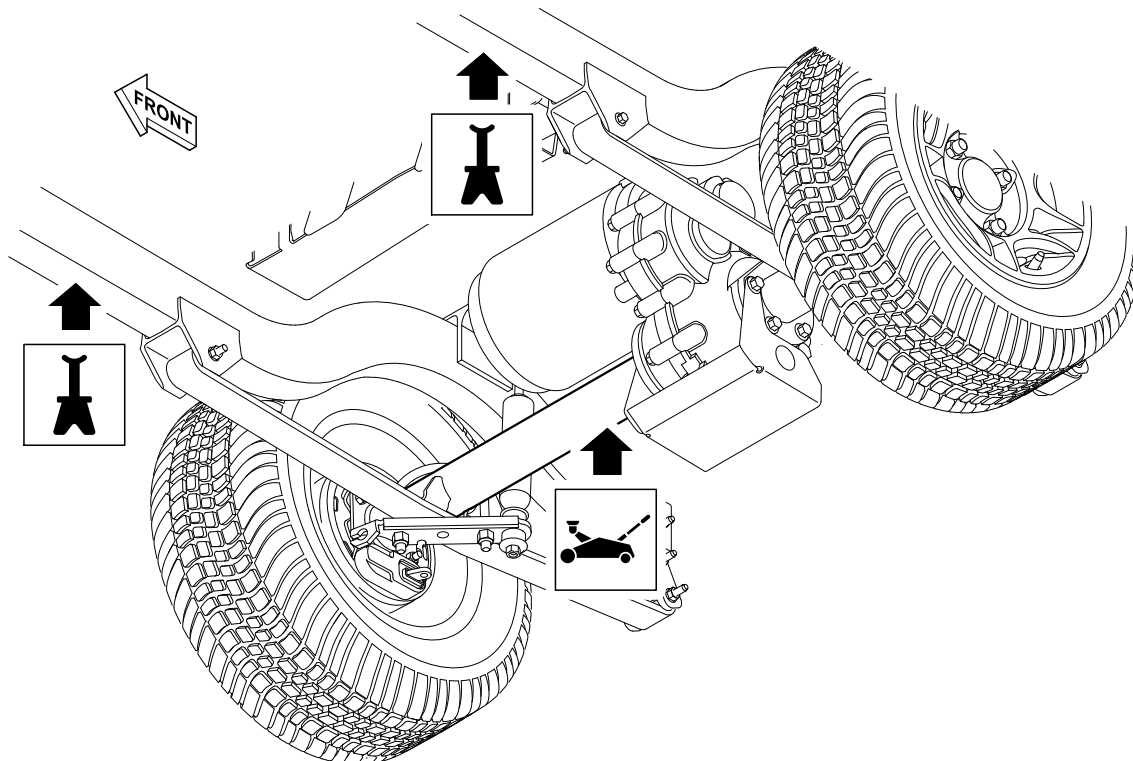

1. Place the jack in the center of the lift point.
2. Lift the vehicle off of the jack stands.
3. Remove the jack stands.
4. Lower the vehicle.

TIRE PRESSURE MEASUREMENT

Before the tire pressure measurement:

- Disable the vehicle.

To measure the tire pressure:

1. Remove the valve stem cap.
2. Use a pressure gauge to measure the tire pressure.
3. Adjust to meet the recommended tire pressure.

Note: Go to the approved wheel and tire assemblies matrix on <http://www.clubcar.com> for information regarding tire type, inflation pressure, and lug nut torque.

4. Install the valve stem cap.

WHEEL ASSEMBLY

WHEEL ASSEMBLY REMOVAL

Before the wheel assembly is removed:

- Disable the vehicle.

To remove the wheel assembly:

1. Remove the wheel cover.
2. Loosen the lug nuts.
3. Lift the vehicle to allow for removal of the wheel assembly.
4. Remove the lug nuts.
5. Remove the wheel assembly.

WHEEL ASSEMBLY INSTALLATION

Before wheel assembly installation:

- Disable the vehicle.

To install the wheel assembly:

1. Lift the vehicle to allow for installation of the wheel assembly.
2. Align the wheel assembly onto the hub of the vehicle.

Note: Make sure that the valve stem points to the outer side of the vehicle.

Note: Make sure that the tire tread is in the correct direction of travel.

3. Tighten the lug nuts until they are hand-tight.
4. Lower the vehicle.
5. Tighten the lug nuts to the recommended torque specification.

Note: Go to the approved wheel and tire assemblies matrix on <http://www.clubcar.com> for information regarding tire type, inflation pressure, and lugnut torque.

6. Install the wheel cover.

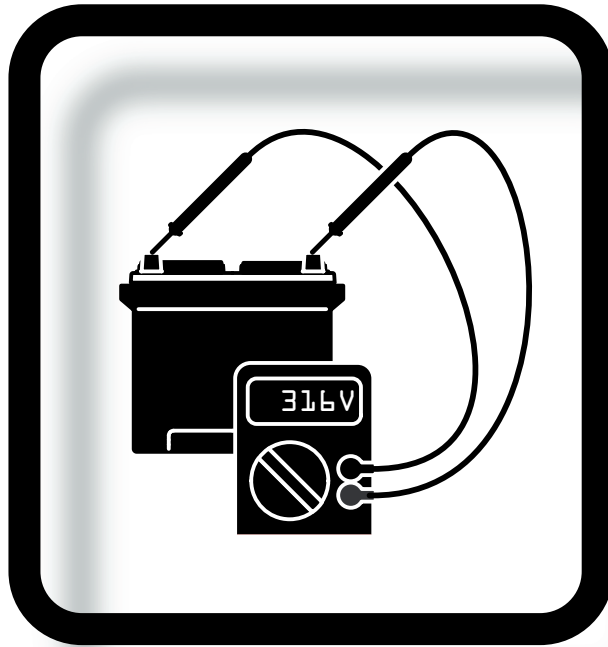

9

BATTERY MAINTENANCE

CAUTION

WATER MAY BOIL OVER AND LEAK BATTERY ACID AND CAUSE PERSONAL INJURY OR PROPERTY DAMAGE. CHARGE THE BATTERIES BEFORE WATER IS ADDED.

LEAD-ACID BATTERIES CONTAIN DANGEROUS MATERIALS THAT CAN CONTAMINATE THE WATER AND SOIL, CAUSE ENVIRONMENTAL DAMAGE, CAUSE PROPERTY DAMAGE, AND CAUSE SERIOUS PERSONAL INJURY. DO NOT ADD TOO MUCH WATER TO THE BATTERIES.

WEAR SAFETY GLASSES OR APPROVED EYE PROTECTION WHEN YOU DO THE SERVICING OF THE VEHICLE. WEAR A FULL FACE SHIELD AND RUBBER GLOVES WHEN NEAR BATTERIES.

BATTERY CLEANING

1. Apply an approved battery cleaner spray or water solution to the battery top and terminals.
Note: The water solution is 1 cup (237 ml) baking soda for each 1 gallon (3.8 l) water.
2. Use a soft bristle brush to clean the battery top and terminals. Remove all corrosion.
3. Use tap water to clean the solution from the batteries. Correctly discard the waste water.
4. If the battery cable has corrosion, have a trained technician replace the battery cable.
5. Make sure the battery cables are tight. If a battery cable is not tight, tighten the hardware to 110 lb·in (12.4 N·m).
6. Let the terminals dry.
7. Apply battery terminal protector spray to the terminals.

BATTERY CHARGING

CHARGING WITH EXTERNAL CHARGER

DANGER

CHARGING LEAD-ACID BATTERIES EMIT HYDROGEN GAS, THAT IS EXPLOSIVE ABOVE 2% AIR CONCENTRATION. CHARGE THE BATTERIES IN A VENTILATED AREA WITHOUT COVERS OR ENCLOSURES.

CHARGING BATTERIES EMIT HYDROGEN GAS, THAT IS EXPLOSIVE ABOVE 2% AIR CONCENTRATION. KEEP BATTERIES AWAY FROM SPARKS AND OPEN FLAMES.

CHARGING BATTERIES EMIT HYDROGEN. HYDROGEN BECOMES AN EXPLOSIVE GAS AT 2% AIR CONCENTRATION. INDIVIDUAL VEHICLES REQUIRE ONE AIR EXCHANGE PER HOUR. FLEET 5 TIMES PER HOUR. THE TOTAL VOLUME OF AIR IN THE CHARGING AREA MUST BE CHANGED AT LEAST FIVE TIMES PER HOUR. EXHAUST FANS MUST BE LOCATED AT THE HIGHEST POINT OF THE ROOF. SPEAK WITH A LOCAL HVAC ENGINEER.

CHARGING THE BATTERIES WITH ACCESSORIES ON CAN CAUSE A FIRE AND SERIOUS PERSONAL INJURY. TURN OFF ALL ACCESSORIES BEFORE CHARGING THE BATTERIES.

WARNING

THE BATTERY CHARGER BECOMES HOT WHEN IT IS ON AND CAN CAUSE A FIRE, PROPERTY DAMAGE, OR SERIOUS PERSONAL INJURY. DO NOT COVER THE BATTERY CHARGER. DO NOT TOUCH. MAKE SURE THAT THE BATTERY CHARGER HAS ADEQUATE AIRFLOW. USE THE HANDLE. KEEP THE BATTERY CHARGER AWAY FROM CLOTHING AND FLAMMABLE MATERIAL.

LOOSE CORD CONNECTIONS CAN CAUSE A FIRE. MAKE SURE THAT ALL CORD CONNECTIONS AT THE RECEPTACLE ARE CLEAN AND TIGHT.

To charge with an external charger:

1. Turn the key to OFF.
2. Turn off all accessories.
3. Connect the AC cord to the charger.
4. Connect the AC cord to the power source.

NOTICE

INCORRECT REMOVAL AND INSTALLATION OF THE DC CORD CAN CAUSE DC CORD DAMAGE AND VEHICLE CHARGER RECEPTACLE DAMAGE. DO NOT TWIST, BEND, OR MOVE THE DC CORD PLUG SIDE TO SIDE. DO NOT PULL ON THE DC CORD. HOLD THE PLUG HANDLE AND PUSH THE PLUG STRAIGHT INTO THE VEHICLE CHARGER RECEPTACLE.

5. Connect the DC cord to the vehicle charger receptacle (1).

Note: The vehicle will start to charge in 10 seconds or less.

When the vehicle starts to charge:

- ON CHG will show on the dash display.
- The multi-purpose buzzer will operate.
- If equipped, the headlights will flash.

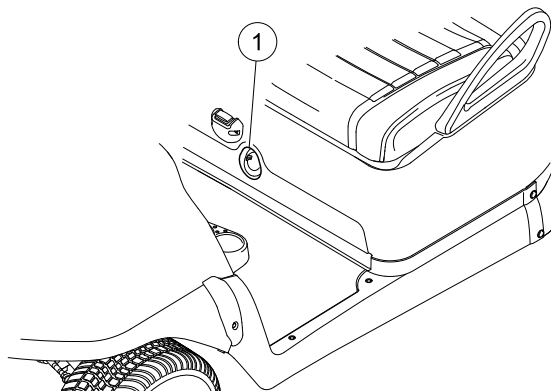

G-130096-000002

Note: When the battery is fully charged, CHARGD will show on the dash display.

⚠ DANGER

IF THE DC CORD IS REMOVED TOO FAST, ARCING AND BURNING CAN CAUSE DAMAGE TO THE PLUG, RECEPTACLE, AND CAUSE THE BATTERIES TO EXPLODE. REMOVE THE DC CORD SLOW.

6. Before vehicle operation, disconnect the DC cord from the vehicle charger receptacle.

CHARGING WITH ONBOARD CHARGER**⚠ DANGER**

CHARGING LEAD-ACID BATTERIES EMIT HYDROGEN GAS, THAT IS EXPLOSIVE ABOVE 2% AIR CONCENTRATION. CHARGE THE BATTERIES IN A VENTILATED AREA WITHOUT COVERS OR ENCLOSURES.

CHARGING BATTERIES EMIT HYDROGEN GAS, THAT IS EXPLOSIVE ABOVE 2% AIR CONCENTRATION. KEEP BATTERIES AWAY FROM SPARKS AND OPEN FLAMES.

CHARGING BATTERIES EMIT HYDROGEN. HYDROGEN BECOMES AN EXPLOSIVE GAS AT 2% AIR CONCENTRATION. INDIVIDUAL VEHICLES REQUIRE ONE AIR EXCHANGE PER HOUR. FLEET 5 TIMES PER HOUR. THE TOTAL VOLUME OF AIR IN THE CHARGING AREA MUST BE CHANGED AT LEAST FIVE TIMES PER HOUR. EXHAUST FANS MUST BE LOCATED AT THE HIGHEST POINT OF THE ROOF. SPEAK WITH A LOCAL HVAC ENGINEER.

CHARGING THE BATTERIES WITH ACCESSORIES ON CAN CAUSE A FIRE AND SERIOUS PERSONAL INJURY. TURN OFF ALL ACCESSORIES BEFORE CHARGING THE BATTERIES.

⚠ WARNING

LOOSE CORD CONNECTIONS CAN CAUSE A FIRE. MAKE SURE THAT ALL CORD CONNECTIONS AT THE RECEPTACLE ARE CLEAN AND TIGHT.

When the Run/Tow-Stow switch is set to RUN, the battery will charge to 100%.

To charge with an onboard charger:

1. Turn the key to OFF.
2. Turn off all accessories.

3. Connect the AC cord (1) to the power source.

Note: The vehicle will start to charge in 2 to 10 seconds.

When the vehicle starts to charge:

- ON CHG will show on the dash display.
- The multi-purpose buzzer will operate 3 times.
- If equipped, the headlights will flash.

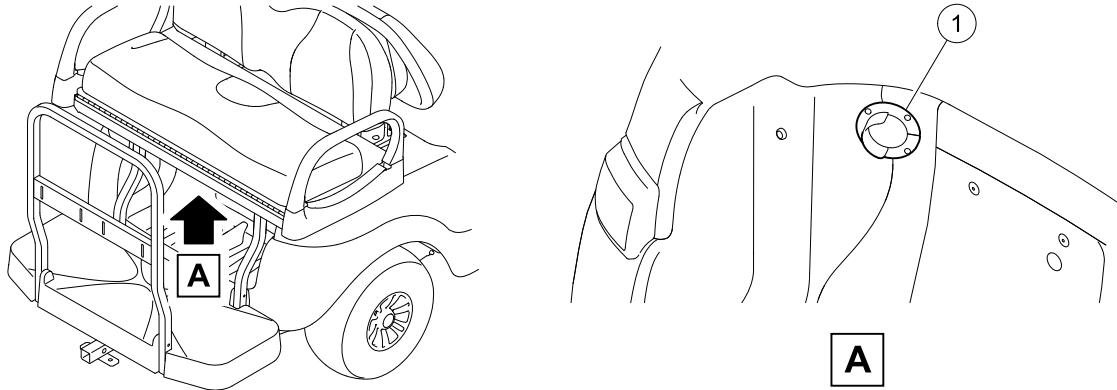

G-200096-000087

Note: When the battery is fully charged, CHARGD will show on the dash display.

4. Before vehicle operation:
 - 4.A Disconnect the AC cord from the power source.
 - 4.B Retract the AC cord.

BATTERY ELECTRICAL CONNECTION

DISCONNECT THE BATTERIES

Before the batteries are disconnected:

- Disable the vehicle.

To disconnect the batteries:



BATTERIES DISCONNECTED OR CONNECTED WITH THE RUN/TOW SWITCH SET TO RUN CAN CAUSE A BATTERY EXPLOSION AND SERIOUS PERSONAL INJURY. SET THE RUN/TOW SWITCH TO TOW BEFORE THE BATTERIES ARE DISCONNECTED OR CONNECTED.

1. Set the Run/Tow switch to TOW.

2. Disconnect the negative (-) cable (1).

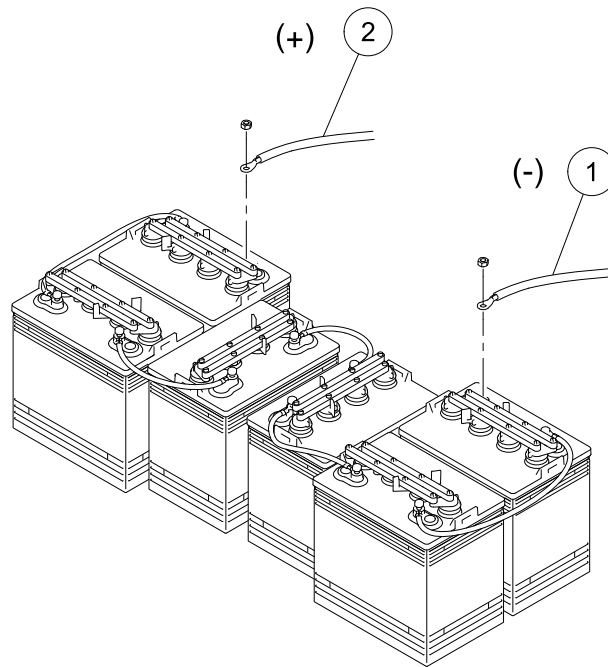

G-130798-000007

3. Disconnect the positive (+) cable (2).
4. Wait 90 seconds for the controller capacitors to discharge.

CONNECT THE BATTERIES

DANGER

BATTERIES DISCONNECTED OR CONNECTED WITH THE RUN/TOW SWITCH SET TO RUN CAN CAUSE A BATTERY EXPLOSION AND SERIOUS PERSONAL INJURY. SET THE RUN/TOW SWITCH TO TOW BEFORE THE BATTERIES ARE DISCONNECTED OR CONNECTED.

1. Set the Run/Tow switch to TOW.

2. Connect the positive (+) cable (2).

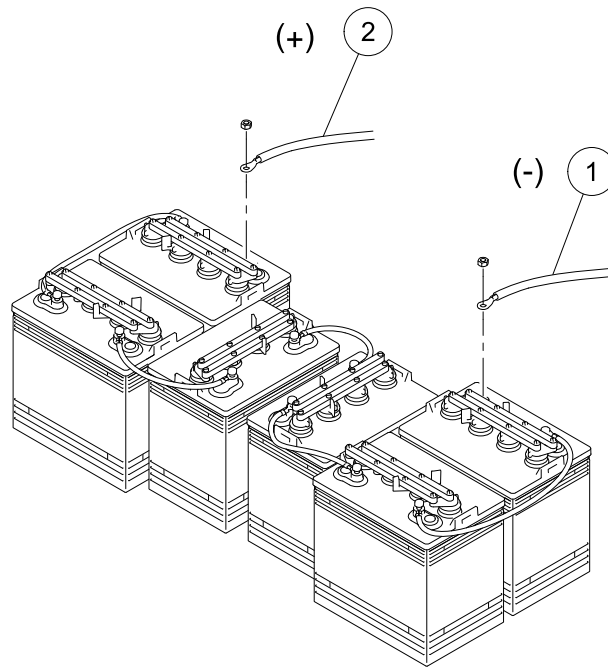

G-130798-000007

3. Connect the negative (-) cable (1).

WARNING

LOOSE BATTERY WIRES CAN CAUSE A FIRE, PROPERTY DAMAGE, OR SERIOUS PERSONAL INJURY. MAKE SURE THAT ALL BATTERY WIRES AND TERMINALS ARE CLEAN AND TIGHTENED CORRECTLY.

4. Tighten the hardware to 110 lb·in (12.4 N·m).
5. Apply battery terminal protector spray to the battery terminals.
6. Set the Run/Tow switch to RUN.

BATTERY HOLD-DOWN

Each hold-down must be tight to prevent the battery movement while the vehicle is in operation. Do not tighten too much or the battery case can crack or buckle.

1. Tighten the hold-down nuts to 110 lb·in (12.4 N·m).

ADD WATER TO A BATTERY WITHOUT SINGLE POINT WATERING SYSTEM

This information is for batteries without a Single Point Watering System (SPWS).

Before water is added:

- Disable the vehicle.

To add water to the batteries:

1. Unlock and remove the cap (1).

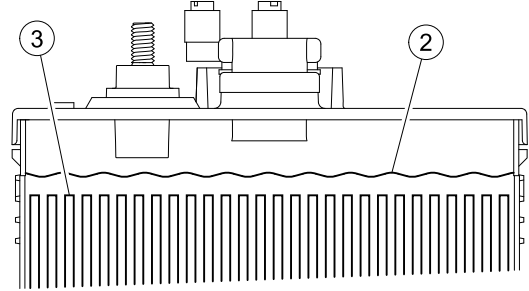
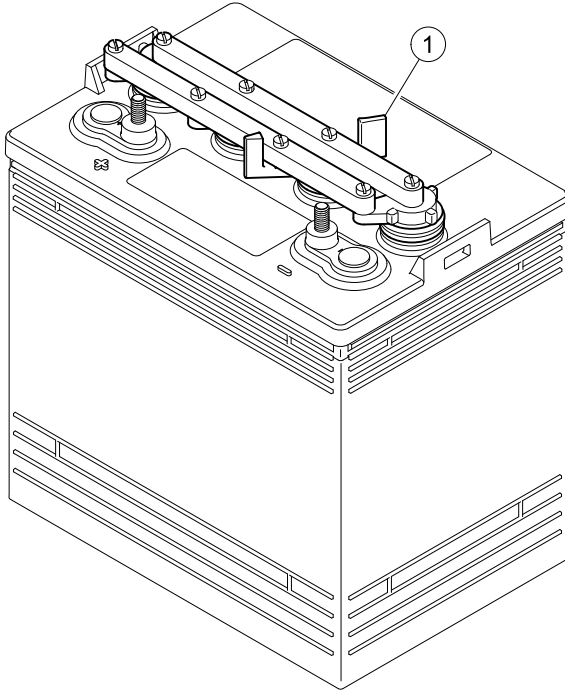

G-130798-000012

2. Make sure that the battery acid (2) is level with or above the top of the plates (3).
3. If the battery acid is level with or above the top of the plates:
 - 3.A Install and lock the cap.
 - 3.B Fully charge the batteries.
4. If the battery acid is below the top of the plates:
 - 4.A Add water until the battery acid is level with the top of the plates.
 - 4.B Install and lock the cap.
 - 4.C Fully charge the batteries.
5. Unlock and remove the cap.
6. Make sure that the battery acid is 0.5 inches (13 mm) above the top of the plates. Add water as necessary.

CAUTION

LOOSE BATTERY CAPS CAN CAUSE BATTERY ACID TO LEAK. FULLY ATTACH THE BATTERY CAPS TO PREVENT LEAKAGE.

7. Install and lock the cap.

DEIONIZER

NOTICE

FREEZING TEMPERATURES WILL CAUSE DAMAGE TO WATER SUPPLY COMPONENTS. DRAIN ALL WATER SUPPLY COMPONENTS. STORE WATER SUPPLY COMPONENTS IN AN EMPTY STATE.

Refer to the deionizer operator and maintenance manual for maintenance and operator information.

ADD WATER TO BATTERIES WITH SINGLE POINT WATERING SYSTEM

CAUTION

LEAD-ACID BATTERIES CONTAIN DANGEROUS MATERIALS THAT CAN CONTAMINATE THE WATER AND SOIL, CAUSE ENVIRONMENTAL DAMAGE, CAUSE PROPERTY DAMAGE, AND CAUSE SERIOUS PERSONAL INJURY. IF BATTERY ACID LEAKS FROM THE BATTERIES, STOP THE FILL PROCESS. DISCONNECT THE PRESSURE REGULATOR FROM THE BATTERY FILL COUPLING. SPEAK WITH YOUR DEALER OR DISTRIBUTOR.

NOTICE

FREEZING TEMPERATURES WILL CAUSE DAMAGE TO WATER SUPPLY COMPONENTS. DRAIN ALL WATER SUPPLY COMPONENTS. STORE WATER SUPPLY COMPONENTS IN AN EMPTY STATE.

1. Add water to the batteries. Refer to the: installation, operation, and maintenance manual, hand pump manual, and deionizer operator and maintenance manual.

WATERING INTERVALS

The watering intervals are affected by:

- Age of the batteries
- Application
- Charging methods
- Local climate

Examine the consumption rates manually. Examine new batteries monthly until consumption rates are known. Examine used batteries weekly until consumption rates are known. The watering interval must maintain the electrolyte level above the top of the plates.

During periods of heavy use, water the batteries no more than one time a week. During periods of light use, water the batteries no more than one time a month. Only add water to a warm battery that is fully charged. Do not add water to the batteries before charging.

WATER QUALITY

OVERVIEW

Water purity is one of the more important factors in the performance and life of the vehicle batteries. Club Car has put an increased importance on water purity and battery maintenance. Club Car recommends the use of distilled water or a deionizer because of the cost of water testing and fluctuations in the daily changes to water quality.

PREFERRED SOURCES

DEIONIZED WATER

Deionized water is water that has all charged mineral ions removed (example: sodium, calcium, iron, copper, and chloride).

Obey the manufacturers' recommendation for filter replacement. A clean filter will make sure that the deionized water quality stays high.

DISTILLED WATER

Distilled water is the most common type of water used in batteries. Distilled water is made by boiling water, collecting the steam from the boiling, and allowing the steam to condense back into water. The distilling process results in a water source which is free of minerals that can lead to the degradation of battery performance and life.

ALTERNATE SOURCES

REVERSE OSMOSIS

Reverse osmosis involves the movement of water through a membrane that lets water pass while trapping solids. The selection of membranes and usage frequency determines the quantity of solids or impurities which get caught and hence the purity quality of the filtered water. Because of the variance in water quality consistency, Club Car recommends the use of the deionizer or distilled water.

TAP WATER

Because of the levels of dissolved minerals and chemicals that can degrade battery performance and life the use of tap water without filtering should be limited. Regular water analyses must be done to check for impurities if unfiltered tap water is used.

WATER IMPURITY

Listed are the maximum permitted water soluble minerals, solids, and contaminates in parts per million and their impact on battery performance.

IMPURITY	PERMITTED CONTENT (PARTS PER MILLION)	IMPURITY EFFECTS
Ammonia	8.0	Slight self-discharge of both plates
Antimony	5.0	Self-discharge, decreases life, and lower on-charge voltage
Arsenic	0.5	Self-discharge and can form poisonous gas
Calcium	40.0	Increase of positive plate shedding
Chloride	5.0	Loss of capacity in plates and greater loss in positive plates
Copper	5.0	Increased self-discharge and lower on-charge voltage

IMPURITY	PERMITTED CONTENT (PARTS PER MILLION)	IMPURITY EFFECTS
Iron	3.0	Increased self-discharge and lower on-charge voltage
Magnesium	40.0	Decreased life
Nickel	None allowed	Intense lowering of on-charge voltage
Nitrates	10.0	Increased sulfation of negative plate
Nitrites	5.0	Plate corrosion, loss of capacity, and decreased life
Platinum	None allowed	Violent self-discharge and lower on-charge voltage
Selenium	2.0	Positive plate shedding
Zinc	4.0	Slight self-discharge of negative plates
Organic and volatile matter	50.0	Corrosion of positive plates
Suspended matter	Trace	None
Total solids	100.0	None

(Page intentionally left blank.)



10

TRANSPORT AND TOW

⚠ DANGER

DO NOT LET PASSENGERS RIDE IN THE VEHICLE OR TRAILER BEING TOWED.

⚠ WARNING

KEEP AWAY FROM THE AREA BETWEEN THE TOW VEHICLE AND THE TOWED VEHICLE OR TRAILER.

DO NOT TOW A CLUB CAR VEHICLE BEHIND A PASSENGER VEHICLE OR TRUCK ON A PUBLIC ROAD. ONLY TRANSPORT A CLUB CAR VEHICLE ON AN APPROVED TRAILER.

⚠ CAUTION

THE VEHICLE CAN FALL OFF THE TRAILER AND CAUSE PROPERTY DAMAGE AND SERIOUS PERSONAL INJURY. MAKE SURE THE VEHICLE IS CORRECTLY SECURED TO THE TRAILER.

BEFORE TRANSPORTING THE VEHICLE ON A TRAILER, REMOVE THE WINDSHIELD. SECURE THE SEAT BOTTOM.

WHEN A TRAILER IS USED ON A PUBLIC ROAD, THE TRAILER MUST MEET ALL FEDERAL, STATE, AND LOCAL REQUIREMENTS SUCH AS TAILLIGHTS AND BRAKE LIGHTS.

PREPARE THE VEHICLE TO BE TOWED

1. Turn the key to OFF.
2. Remove the key. Keep the key in a safe area.
3. Set the Forward / Neutral / Reverse control (FNR) to N.
4. Set the Run/Tow switch to TOW.

TOWING A TRAILER OR VEHICLE

⚠ CAUTION

USE EXTREME CAUTION WHEN TOWING A TRAILER OR VEHICLE. DO NOT MAKE SHARP TURNS WHEN TOWING A TRAILER OR VEHICLE. DO NOT TOW A TRAILER OR VEHICLE ON PUBLIC ROADS OR HIGHWAYS. DECREASE THE VEHICLE SPEED WHEN TOWING A TRAILER OR VEHICLE.

Use only a Club Car approved tow kit.

1. Prepare the vehicle to be towed.
2. Use a Club Car approved tow kit to tow the vehicle.
3. Tow the trailer or vehicle under 5 mph (8 kmh).

VEHICLE TRANSPORT PREPARATION

⚠ CAUTION

USE EXTREME CAUTION WHEN TRANSPORTING THE VEHICLE ON A TRAILER. REFER TO THE TOW VEHICLE OPERATOR MANUAL.

The vehicle is not designed to be towed at speeds over 5 mph. If movement over long distances or on public roads is necessary, transport the vehicle on a trailer. Use a trailer with appropriate load rating.

1. Set the park brake.
2. Set the Forward / Neutral / Reverse control (FNR) to N.
3. Turn the key to OFF.
4. Remove the key. Keep the key in a safe area.
5. Set the Run/Tow switch to TOW.
6. Remove all cargo from the vehicle.
7. Remove the windshield from the vehicle.
8. Secure all doors, access panels, seat bottoms, and windshield.
9. Examine the vehicle for loose parts. Tighten as necessary.
10. Secure the vehicle to the trailer.

VEHICLE TRANSPORT RECOVERY

1. Make sure that the trailer is correctly configured to remove the vehicle from the trailer safely.
2. Remove all materials used to secure the vehicle to the trailer.
3. Examine the vehicle for loose parts. Tighten as necessary.
4. Install the windshield.

(Page intentionally left blank.)



11

EXTENDED STORAGE

WARNING

FROZEN BATTERY ACID CAN CAUSE DAMAGE INCLUDING LEAKS AND EXPLOSIONS. IF THE BATTERY ACID FREEZES, REPLACE THE BATTERY BEFORE CHARGING OR USE. BATTERIES IN A LOW STATE OF CHARGE WILL FREEZE AT LOW TEMPERATURES. KEEP THE BATTERIES IN A HIGH STATE OF CHARGE.

UNINTENDED VEHICLE OPERATION CAN CAUSE SERIOUS PERSONAL INJURY OR DEATH. BEFORE LEAVING THE VEHICLE OR DURING VEHICLE MAINTENANCE, DISABLE THE VEHICLE.

EXTENDED STORAGE PREPARATION

Keep sufficient water levels in each battery cell for a minimum of two weeks before extended storage to make sure proper mixing of water and battery acid. If necessary, add water as necessary then correctly charge batteries.

Note: It takes approximately five charge cycles with a minimum of 10-amp hours of use after each charge to correctly mix the water with battery acid.

To prepare your vehicle for extended storage:

1. Turn off all electronic accessories.
2. Set the Forward / Neutral / Reverse control (FNR) to N.
3. Turn the key to OFF.
4. Remove the key. Keep the key in a safe area.
5. Put chocks against the wheels.

Note: Do not engage the park brake.
6. Remove all cargo and personal items.
7. Run/Tow switch position:
 - 7.A On vehicles equipped with Visage that will have remote monitoring, set the Run/Tow switch to RUN.
 - 7.B On vehicles equipped with Visage that will not have remote monitoring, set the Run/Tow switch to TOW.
 - 7.C On all other vehicles, set the Run/Tow switch to TOW.
8. Clean the batteries.
9. Tighten all battery cable connections to 110 lb·in (12.4 N·m).
10. Keep the vehicle in a cool and dry area to keep battery self-discharge to a minimum.
11. Adjust pressure in each tire to the recommended tire pressure.
12. Clean the vehicle.
13. If one or more conditions shown cannot be done while in storage, disconnect the negative (-) battery cable. Make sure that the negative (-) battery cable does not touch the battery terminal.
 - The battery charger must stay connected to an electric outlet
 - AC electrical power will be available during storage
 - Battery acid levels will be kept at a sufficient level while in storage

14. If all conditions shown can be done while in storage, do as follows:

- The battery charger must stay connected to an electric outlet
- AC electrical power will be available during storage
- Battery battery acid levels will be kept at a sufficient level while in storage

14.A Connect the battery charger to the vehicle. Keep battery chargers connected during storage. The charger will automatically connect when necessary.

14.B Examine the battery acid level and charger function monthly.

Note: The charger is operating correctly when the blue light is on and the triangular light is off.

RETURN TO SERVICE FROM EXTENDED STORAGE

1. Clean the batteries.
2. If the batteries were disconnected, connect the batteries.
3. Fully charge the batteries.
4. Set the Run/Tow switch to RUN.
5. Set the Forward / Neutral / Reverse control (FNR) to N.
6. Adjust the pressure in each tire to the recommended tire pressure.
7. Have a trained technician lubricate the vehicle.
8. Do a daily pre-operation safety checklist.
9. Do a vehicle performance inspection.

(Page intentionally left blank.)



12

WARRANTIES

LIMITED WARRANTY**WARRANTY**

Club Car, LLC ("Club Car") hereby warrants to the original purchaser or lessee, as those terms are defined herein, and subject to the provisions, limitations and exclusions in this limited warranty, that its new vehicle or new component purchased from Club Car or an Authorized Dealer or Distributor shall be free from defects in material and workmanship under normal use and service for the periods stated below, subject to the provisions, limitations and exclusions in this limited warranty.

This limited warranty covers material, workmanship and repair labor cost as to those items specifically listed below for the periods specified. Such repair labor shall be performed only by Club Car, its Authorized Dealers or Distributors, or a service agency approved by Club Car. For repairs made by qualified technicians other than Club Car's factory technicians or an Authorized Dealer or Distributor, Club Car will provide only the replacement parts or components.

If the warranty registration form is not completed and returned to Club Car at the time of the original retail sale, the Purchaser must provide proof of date of purchase with any warranty claim.

WARRANTY TIMEFRAME

ITEM	SUB-ITEMS	COVERAGE
VEHICLE MAINFRAME	Not applicable	Limited Lifetime
SUSPENSION	Steering gearbox, steering column, shocks, and leaf springs	3 years
ELECTRIC POWERTRAIN	Electric motor, transaxle, and MCOR	3 years
DEEP CYCLE BATTERY	Amp hours as recorded by the controller or years specified in chart, whichever occurs first, for vehicles properly maintained per originally supplied vehicle operator manual.	3 years or 23,000 hours
MAJOR ELECTRONICS	Solid state speed controller and battery charger	3 years
OTHER ELECTRONICS	VCM	3 years
PEDAL GROUP	Pedal group mechanical assembly, brake cluster assemblies, and brake cables	3 years
SEATS	Seat bottom, seat back, and armrests	3 years
CANOPY SYSTEM	Canopy, rear canopy supports, drainage system, and structural accessory module (SAM)	3 years
BODY GROUP	Beauty panels and front/rear underbody	3 years

ALL REMAINING COMPONENTS	Solenoid, limit switches, voltage regulator, F&R switch, and options and accessories supplied by Club Car, including components not specified otherwise	2 years
NON-STANDARD ACCESSORIES	Any original Club Car manufactured equipment, accessories, and options purchased from Club Car and field installed by an authorized Club Car dealer and distributor, including: sound system, canopy, rear canopy supports, including components not specified otherwise.	1 year

EXCLUSIONS

Excluded from any Club Car warranty is damage to a vehicle or component resulting from a cause other than a defect including poor maintenance, neglect, abuse, accident and collision, maintenance adjustments, unreasonable or unintended strain or use, improper installation of accessories, installation of parts or accessories that are not original equipment including Club Car approved or non-approved GPS systems, non-approved alteration, and acts of God. Also excluded from any Club Car warranty are all fuses, filters, decals (except safety decals), lubricants, routine wear items such as engine mounts, bed floor lining, mats, pads, spark plugs, light bulbs, brake pads, belts, brushes, solenoids, bushings, drive buttons, cosmetic deterioration, and items that deteriorate, fade or fail due to exposure or ordinary wear and tear.

The provisions of this limited warranty shall not apply to failure due to the following conditions:

- Batteries
 - Improper charging of a vehicle due to the use of a battery charger model not approved by Club Car for use with the vehicle.
 - Use of water in batteries, including tap water, that contains impurities. Distilled water or a properly maintained, Club Car approved battery water deionizer and filter system must be used to ensure water quality.
 - Abuse such as overcharging, undercharging, improper fluid levels, loose wiring and fasteners, or rusted or corroded hardware.
 - Use of energy management systems that do not allow a minimum of 12 hours of charge time to assure proper charging.
 - Use of any accessories that do not draw power off the complete system voltage.
 - Neglect, breakage, freezing, fire, explosion, wreckage, melted terminal posts, the addition of any chemical, or the operation of the battery in an uncharged condition (below half charge 1.200 specific gravity); the installation of the batteries in reverse or recharging in reverse, breakage of containers, covers, or terminal post, or batteries used in applications for which they were not designed.
 - A battery damaged by a defective charger or batteries in vehicles that do not receive proper charging.
 - A vehicle not having an operational charger on a circuit that has the parameters specified in the vehicle operator’s manual (the number of operational chargers must equal the number of operational vehicles), or use of an unapproved algorithm.
- Lack of proper maintenance such as preventive maintenance checks, proper rotation of vehicles in a fleet application, maintaining proper tire pressure and alignment and tightening loose wire connections as outlined in the operator’s manual.

- Damages caused by improper installation of the component.
- Failed semiconductor parts such diodes and fuses that are vulnerable to electrical overloads (including lightning) beyond the control of Club Car.
- Damaged charger AC and DC cord set with plug, which is a wear item and subject to user abuse.

Without limiting the generality of the foregoing in any way, and as part of its limited warranty exclusion, Club Car does not warrant that its vehicle or components such as batteries, computer, controller or electrical device are suitable for use in any application other than in its products. As in the use of any vehicle, batteries, computer, controller or electrical device, a prudent owner will read and study the operator's manual, the operator instructions and the warning labels; and will exercise due care in working on or around vehicles, batteries or electrical devices.

Transportation expenses for warranty services are also excluded from this warranty.

VOIDING OF WARRANTY

This and any other warranty shall be void if the vehicle or component is damaged, involved in an accident, abused or used in an unintended manner or shows indications that it has been altered in any way, including, but not limited to, modification of the speed governor, braking system, steering, transaxle, or other operating systems of the car to cause it to perform outside club car specifications. The warranty is likewise void if the vehicle shows indications that reasonable or necessary maintenance as outlined in the operator's manual and maintenance and service manual was not performed at the time and in the manner specified in such manuals.

SOLE REMEDY

Club Car's liability under this limited warranty or in any action whether based upon warranty, contract, negligence, strict product liability or otherwise, shall be the repair or replacement, at Club Car's option, of the vehicle or component thereof that Club Car deems to be defective. Replacement shall mean furnishing, during the applicable limited warranty period, a new vehicle or factory-reconditioned vehicle or component thereof that is identical or reasonably equivalent to the warranted product or component at no cost to the purchaser. Repair shall mean remedying a defect in the vehicle or component thereof at no cost to the purchaser during the applicable limited warranty period. Club Car reserves the right to test and recharge any component returned for adjustment. If Club Car elects to repair the vehicle or component, it may provide factory-reconditioned parts or components. All parts and components replaced under warranty shall become the property of Club Car.

DISCLAIMER

This limited warranty is exclusive. Club Car makes no other warranty of any kind, expressed or implied. Any implied warranties of merchantability or fitness for a particular purpose are hereby disclaimed by Club Car and excluded from this warranty. The Purchaser and Club Car expressly agree that the sole remedy of the replacement or repair of the defective vehicle or component thereof is the sole remedy of the Purchaser. Club Car makes no other representation or warranty of any kind, and no representative, employee, distributor or dealer of Club Car has the authority to make or imply any representation, promise or agreement, which in any way varies the terms of this warranty.

In the event that another pre-printed warranty document, certificate or both offered by or through Club Car at the time of sale of this vehicle (each an "Additional Warranty Document") is deemed to conflict with the limitations or exclusions contained herein, the limitations and exclusions contained herein shall continue to apply to both this limited warranty statement and, to the maximum extent permitted by law, to each Additional Warranty Document.

NO CONSEQUENTIAL DAMAGES

In no event shall Club Car be liable for any incidental or consequential damages including, but not limited to, loss related to property other than the vehicle, loss of use, loss of time, inconvenience, or any other economic loss.

Some states allow neither limitation on the duration of an implied warranty nor exclusions or limitation of incidental or consequential damages. Therefore, the above limitations or exclusions may not apply to you. This warranty gives you specific legal rights, and you may also have other rights, which vary from state to state.

HOW TO MAKE A WARRANTY CLAIM

To make a warranty claim under this limited warranty, you must present the vehicle or defective component with evidence of proof of purchase date and number of amp hours (if applicable) to an authorized Club Car dealer.

For warranty-related communication, contact:

E-mail

cci_warrantyadministration@clubcar.com

Postal Service

Club Car, LLC
Attention: Warranty Services
4125 Washington Rd.
Evans, Georgia 30809
Unites States Of America

Publication Part Number TPCC01DU00EN020

Edition Code A



Club Car, LLC
P.O. Box 204658
Augusta, GA 30917-4658
USA

Web www.clubcar.com
Phone 1 706 258 2225
1 800 ClubCar
Fax 1 706 863 5858